



QUADRA-F



QUADRA-Q

A timeless design and clear lines distinguish the shelving system **QUADRA** from other shelving systems on the market. The customer has the choice of two different design variants on this system with square tubes.

Scale 1 : 1

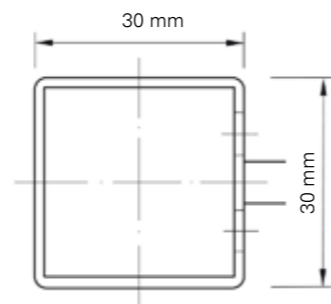

Integrated book end-stops





Perforated side panel  
with round holes RG 5/25



End panels are available with different perforations, either with round or square holes, a design that underlines the plain and simple beauty of the system.

Our accessory catalogue for Schulz Shelving Systems provides more information about additional furnishing options for the QUADRA shelving system.

Perforated side panel  
with square holes QG 10/62,5



# QUADRA

Clear lines – well defined

Quadra is a shelf and furnishing programme for high-quality, timeless library interiors.

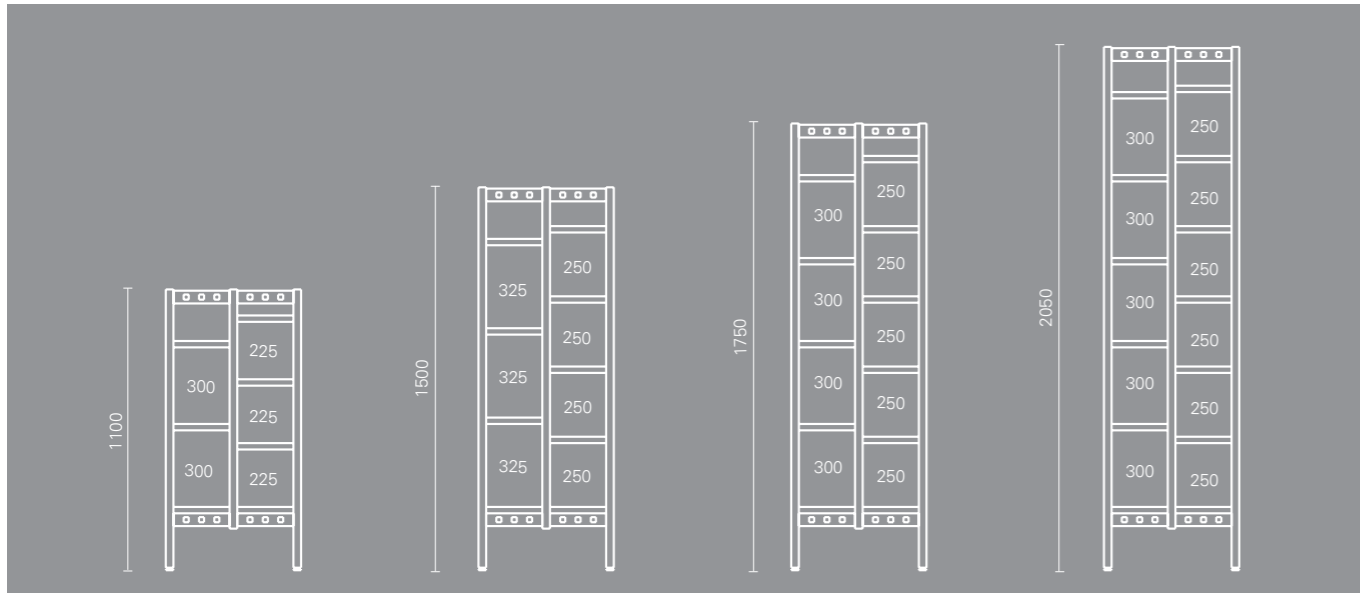

The customer can select from two different designs of this square tube system.

The Quadra-F has an almost minimalistic design, whereas the Quadra-Q differentiates itself with the square design on the frame.

Both timeless designs with clear lines.

End panels with different perforation designs, available with round or square holes emphasize the plain elegance of both alternatives.

Our furniture programmes demonstrate their flexibility during everyday use.

The systems are widespread; all areas of use in a library can be well covered.

The abundant range of accessories from our Schulz Shelving System Accessory Catalogue makes our programmes adaptable and allows for an uncompromising orientation towards all possible customer requests.

Function as well as quality, Schulz Shelving Systems have been designed for long-term use and for the high strains in library areas.

Best production standards, high resilience and highest quality levels – officially proven and confirmed - contribute significantly to the conservation of value of our furniture.



QUADRA-F



QUADRA-Q

Colors and surfaces in accordance with the symbols on the Schulz ColorRange:

● Colors:  
for lacquered metal or wood

■ Surfaces:  
in wood or plastic



## Single-sided Bays

### Single-sided starter bay QUADRA-F with frame traverse, without shelves

Lacquered metal, D 280 mm for shelf depth 250 mm = M

		Axle size 1000 mm	Axle size 900 mm	Axle size 750 mm	Axle size 500 mm
H 1100 mm	<b>Item no.</b>	B 1100 GWM QU	B 1100 GUM QU	B 1100 GSM QU	B 1100 GRM QU
H 1500 mm	<b>Item no.</b>	B 1100 CWM QU	B 1100 CUM QU	B 1100 CSM QU	B 1100 CRM QU
H 1750 mm	<b>Item no.</b>	B 1100 AWM QU	B 1100 AUM QU	B 1100 ASM QU	B 1100 ARM QU
H 2050 mm	<b>Item no.</b>	B 1100 DWM QU	B 1100 DUM QU	B 1100 DSM QU	B 1100 DRM QU

For shelf 300 mm = N (D 330 mm) the M in the item no. is replaced by an N.

### Single-sided add-on bay QUADRA-F with frame traverse, without shelves

Lacquered metal, D 280 mm for shelf depth 250 mm = M

		Axle size 1000 mm	Axle size 900 mm	Axle size 750 mm	Axle size 500 mm
H 1100 mm	<b>Item no.</b>	B 1200 GWM QU	B 1200 GUM QU	B 1200 GSM QU	B 1200 GRM QU
H 1500 mm	<b>Item no.</b>	B 1200 CWM QU	B 1200 CUM QU	B 1200 CSM QU	B 1200 CRM QU
H 1750 mm	<b>Item no.</b>	B 1200 AWM QU	B 1200 AUM QU	B 1200 ASM QU	B 1200 ARM QU
H 2050 mm	<b>Item no.</b>	B 1200 DWM QU	B 1200 DUM QU	B 1200 DSM QU	B 1200 DRM QU

For shelf depth 300 mm = N (D 330 mm) the M in the item no. is replaced by an N.

## Double-sided Bays

### Double-sided starter bay QUADRA-F with frame traverse, without shelves

Lacquered metal, D 530 mm for shelf depth 250 mm = M

		Axle size 1000 mm	Axle size 900 mm	Axle size 750 mm	Axle size 500 mm
H 1100 mm	<b>Item no.</b>	B 1300 GWM QU	B 1300 GUM QU	B 1300 GSM QU	B 1300 GRM QU
H 1500 mm	<b>Item no.</b>	B 1300 CWM QU	B 1300 CUM QU	B 1300 CSM QU	B 1300 CRM QU
H 1750 mm	<b>Item no.</b>	B 1300 AWM QU	B 1300 AUM QU	B 1300 ASM QU	B 1300 ARM QU
H 2050 mm	<b>Item no.</b>	B 1300 DWM QU	B 1300 DUM QU	B 1300 DSM QU	B 1300 DRM QU

For shelf depth 300 mm = N (D 630 mm) the M in the item no. is replaced by an N.

### Double-sided add-on bay QUADRA-F with frame traverse, without shelves

Lacquered metal, D 530 mm for shelf depth 250 mm = M

		Axle size 1000 mm	Axle size 900 mm	Axle size 750 mm	Axle size 500 mm
H 1100 mm	<b>Item no.</b>	B 1400 GWM QU	B 1400 GUM QU	B 1400 GSM QU	B 1400 GRM QU
H 1500 mm	<b>Item no.</b>	B 1400 CWM QU	B 1400 CUM QU	B 1400 CSM QU	B 1400 CRM QU
H 1750 mm	<b>Item no.</b>	B 1400 AWM QU	B 1400 AUM QU	B 1400 ASM QU	B 1400 ARM QU
H 2050 mm	<b>Item no.</b>	B 1400 DWM QU	B 1400 DUM QU	B 1400 DSM QU	B 1400 DRM QU

For shelf depth 300mm = N (D 630mm) the M in the item no. is replaced by an N.

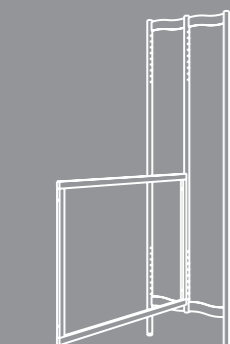
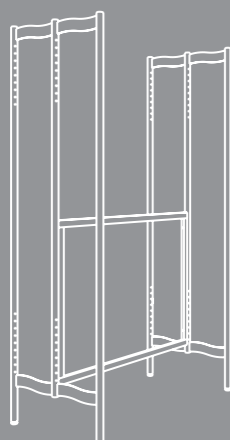
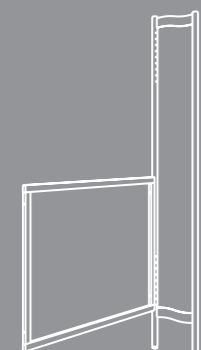

## Single-sided Bays

### Single-sided starter bay QUADRA-Q with frame traverse, without shelves

Lacquered metal, D 280 mm for shelf depth 250 mm = M

		Axle size 1000 mm	Axle size 900 mm	Axle size 750 mm	Axle size 500 mm
H 1100 mm	<b>Item no.</b>	B 1101 GWM QU	B 1101 GUM QU	B 1101 GSM QU	B 1101 GRM QU
H 1500 mm	<b>Item no.</b>	B 1101 CWM QU	B 1101 CUM QU	B 1101 CSM QU	B 1101 CRM QU
H 1750 mm	<b>Item no.</b>	B 1101 AWM QU	B 1101 AUM QU	B 1101 ASM QU	B 1101 ARM QU
H 2050 mm	<b>Item no.</b>	B 1101 DWM QU	B 1101 DUM QU	B 1101 DSM QU	B 1101 DRM QU

For shelf depth 300mm = N (D 330mm) the M in the item no. is replaced by an N.

### Single-sided add-on bay QUADRA-Q with frame traverse, without shelves

Lacquered metal, D 280 mm for shelf depth 250 mm = M

		Axle size 1000 mm	Axle size 900 mm	Axle size 750 mm	Axle size 500 mm
H 1100 mm	<b>Item no.</b>	B 1201 GWM QU	B 1201 GUM QU	B 1201 GSM QU	B 1201 GRM QU
H 1500 mm	<b>Item no.</b>	B 1201 CWM QU	B 1201 CUM QU	B 1201 CSM QU	B 1201 CRM QU
H 1750 mm	<b>Item no.</b>	B 1201 AWM QU	B 1201 AUM QU	B 1201 ASM QU	B 1201 ARM QU
H 2050 mm	<b>Item no.</b>	B 1201 DWM QU	B 1201 DUM QU	B 1201 DSM QU	B 1201 DRM QU

For shelf depth 300mm = N (D 330mm) the M in the item no. is replaced by an N.

## Double-sided Bays

### Double-sided starter bay QUADRA-Q with frame traverse, without shelves

Lacquered metal, D 530 mm for shelf depth 250 mm = M

		Axle size 1000 mm	Axle size 900 mm	Axle size 750 mm	Axle size 500 mm
H 1100 mm	<b>Item no.</b>	B 1301 GWM QU	B 1301 GUM QU	B 1301 GSM QU	B 1301 GRM QU
H 1500 mm	<b>Item no.</b>	B 1301 CWM QU	B 1301 CUM QU	B 1301 CSM QU	B 1301 CRM QU
H 1750 mm	<b>Item no.</b>	B 1301 AWM QU	B 1301 AUM QU	B 1301 ASM QU	B 1301 ARM QU
H 2050 mm	<b>Item no.</b>	B 1301 DWM QU	B 1301 DUM QU	B 1301 DSM QU	B 1301 DRM QU

For shelf depth 300 mm = N (D 630 mm) the M in the item no. is replaced by an N.

### Double-sided add-on bay QUADRA-Q with frame traverse, without shelves

Lacquered metal, D 530 mm for shelf depth 250 mm = M

		Axle size 1000 mm	Axle size 900 mm	Axle size 750 mm	Axle size 500 mm
H 1100 mm	<b>Item no.</b>	B 1401 GWM QU	B 1401 GUM QU	B 1401 GSM QU	B 1401 GRM QU
H 1500 mm	<b>Item no.</b>	B 1401 CWM QU	B 1401 CUM QU	B 1401 CSM QU	B 1401 CRM QU
H 1750 mm	<b>Item no.</b>	B 1401 AWM QU	B 1401 AUM QU	B 1401 ASM QU	B 1401 ARM QU
H 2050 mm	<b>Item no.</b>	B 1401 DWM QU	B 1401 DUM QU	B 1401 DSM QU	B 1401 DRM QU

For shelf depth 300 mm = N (D 630 mm) the M in the item no. is replaced by an N.

## Add-on Front-Side Bay

### Add-on front-side bay without shelves

As finish on front sides of double-sided bays.

With a shelf depth of 250 mm; for equipping with metal or wooden shelves.

Axle size 500 mm; lacquered metal, incl. fastening material.

W 530 mm, D 280 mm

H 1100 mm	<b>Item no.</b>	B 1500 GRM QU QUADRA-F
H 1500 mm	<b>Item no.</b>	B 1500 CRM QU QUADRA-F
H 1750 mm	<b>Item no.</b>	B 1500 ARM QU QUADRA-F
H 2050 mm	<b>Item no.</b>	B 1500 DRM QU QUADRA-F

H 1100 mm	<b>Item no.</b>	B 1501 GRM QU QUADRA-Q
H 1500 mm	<b>Item no.</b>	B 1501 CRM QU QUADRA-Q
H 1750 mm	<b>Item no.</b>	B 1501 ARM QU QUADRA-Q
H 2050 mm	<b>Item no.</b>	B 1501 DRM QU QUADRA-Q

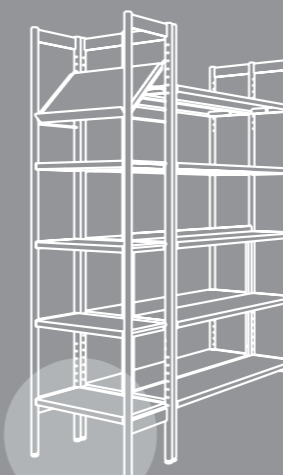

## Equipment for Front-sided Bays

### Slanted bay 60°

For the presentation of books, magazines etc.

For hanging on the front-sides of double-sided bays.

Lacquered metal; incl. hanging kit, W 469 mm

D 290 mm	<b>Item no.</b>	B 8222 0M0 QU
----------	-----------------	---------------

### Front-side shelf

For hanging on front-sides of double-sided bays.

Lacquered metal; incl. hanging kit; W 469 mm, H 120 mm

D 250 mm	<b>Item no.</b>	B 8221 0M0 QU
----------	-----------------	---------------

## Wheel Sets for Double-sided Bays

### Set of castors for double-sided bays

Can be easily retrofitted for double-sided bays with a shelf depth of 250 mm.

The special construction helps to avoid an uncomfortable offset in height

with non-moving shelves; beyond that, the shelf also

receives an additional horizontal stiffener.

Two set of castors are required for basic bays, one set for add-on bays.

Angled sheet metal, lacquered; incl. fastening material and two wheels.

W 550 mm

<b>Item no.</b>	B 8013 0M0 QU	Standard type for PVC and carpet floors
<b>Item no.</b>	B 8013 0M1 QU	Variant type for wooden and stone floors

## Metal shelves

### Metal shelf, including hanging kit

Lacquered metal

		Axle size 1000 mm	Axle size 900 mm	Axle size 750 mm	Axle size 500 mm
D 250 mm	<b>Item no.</b>	B 2110 MW0 QU	B 2110 MU0 QU	B 2110 MS0 QU	B 2110 MR0 QU
D 300 mm	<b>Item no.</b>	B 2110 NW0 QU	B 2110 NU0 QU	B 2110 NS0 QU	B 2110 NR0 QU

### Metal shelf with book stop, including hanging kit

Lacquered metal

		Axle size 1000 mm	Axle size 900 mm	Axle size 750 mm	Axle size 500 mm
D 250 mm	<b>Item no.</b>	B 2111 MW0 QU	B 2111 MU0 QU	B 2111 MS0 QU	B 2111 MR0 QU
D 300 mm	<b>Item no.</b>	B 2111 NW0 QU	B 2111 NU0 QU	B 2111 NS0 QU	B 2111 NR0 QU

### Metal magazine shelf, including hanging kit

With front stop, depth 300 mm.

For bays with a shelf depth of 250 mm and 300 mm. Lacquered metal

Bay depth		Axle size 1000 mm	Axle size 900 mm	Axle size 750 mm	Axle size 500 mm
D 276 mm	<b>Item no.</b>	B 2611 MW0 QU	B 2611 MU0 QU	B 2611 MS0 QU	B 2611 MR0 QU
D 524 mm	<b>Item no.</b>	B 2611 NW0 QU	B 2611 NU0 QU	B 2611 NS0 QU	B 2611 NR0 QU

## Wooden Shelves

### Wooden shelf, including hanging kit

veneered wood / plastic coated

		Axle size 1000 mm	Axle size 900 mm	Axle size 750 mm	Axle size 500 mm
D 250 mm	<b>Item no.</b>	B 2170 MW0 QU	B 2170 MU0 QU	B 2170 MS0 QU	B 2170 MR0 QU
D 300 mm	<b>Item no.</b>	B 2170 NW0 QU	B 2170 NU0 QU	B 2170 NS0 QU	B 2170 NR0 QU

### Wooden shelf with guiding rail for book support, including hanging kit

veneered wood / plastic coated

With guiding rail for book support (for book support, model BSD 22/28)

		Axle size 1000 mm	Axle size 900 mm	Axle size 750 mm	Axle size 500 mm
D 250 mm	<b>Item no.</b>	B 2172 MW0 QU	B 2172 MU0 QU	B 2172 MS0 QU	B 2172 MR0 QU
D 300 mm	<b>Item no.</b>	B 2172 NW0 QU	B 2172 NU0 QU	B 2172 NS0 QU	B 2172 NR0 QU

### Wooden shelf with book stop, including hanging kit

veneered wood / plastic coated

		Axle size 1000 mm	Axle size 900 mm	Axle size 750 mm	Axle size 500 mm
D 250 mm	<b>Item no.</b>	B 2171 MW0 QU	B 2171 MU0 QU	B 2171 MS0 QU	B 2171 MR0 QU
D 300 mm	<b>Item no.</b>	B 2171 NW0 QU	B 2171 NU0 QU	B 2171 NS0 QU	B 2171 NR0 QU

## Wooden Shelves

### Wooden shelf with book stop and guiding rail

for book supports, incl. hanging kit.

veneered wood / plastic coated

1 2

With guiding rail for book support (for book support, model BSD 22/28)

		Axle size 1000 mm	Axle size 900 mm	Axle size 750 mm	Axle size 500 mm
D 250 mm	<b>Item no.</b>	B 2173 MW0 QU	B 2173 MU0 QU	B 2173 MS0 QU	B 2173 MR0 QU
D 300 mm	<b>Item no.</b>	B 2173 NW0 QU	B 2173 NU0 QU	B 2173 NS0 QU	B 2173 NR0 QU

### Magazine shelf, wood, incl. hanging kit

with front stop, adjustable slant, depth 300 mm,

veneered wood / plastic coated

1 2

Additional slanting braces for bays with a shelf depth of 300 mm.

Bay depth		Axle size 900 mm	Axle size 750 mm	Axle size 500 mm
Axle size 1000 mm				
D 250 mm	<b>Item no.</b>	B 2671 MW0 QU	B 2671 MU0 QU	B 2671 MS0 QU
D 300 mm	<b>Item no.</b>	B 2671 NW0 QU	B 2671 NU0 QU	B 2671 NS0 QU
				B 2671 MR0 QU
				B 2671 NR0 QU

## Metal and Wooden Pull-Out Shelves

### Pull-out shelf, flush mounted

Pull-out shelf on telescopic rails

For mounting under metal or wooden shelves from axle size 750 mm.

Pull-out is flush mounted with shelf when closed.

Pull-out depth 245 mm, width 600 mm,

incl. fastening material and tilt stops

For supporting shelves

D 250 mm	<b>Item no.</b>	B 2000 M00 QU	Metal pull-out for metal shelves
D 300 mm	<b>Item no.</b>	B 2000 N00 QU	Metal pull-out for metal shelves

D 250 mm	<b>Item no.</b>	B 2002 M00 QU	Wooden pull-out for wooden shelves
D 300 mm	<b>Item no.</b>	B 2002 N00 QU	Wooden pull-out for wooden shelves

### Pull-out shelf with overlap

Pull-out shelf on telescopic rails

For mounting under metal or wooden shelves from axle size 750 mm.

Pull-out is overlapping 50 mm over shelf when closed and

can be better identified as pull-out shelf.

Pull-out depth 295 mm, width 600 mm,

incl. fastening material and tilt stops

For supporting shelves

D 250 mm	<b>Item no.</b>	B 2001 M00 QU	Metal pull-out for metal bay bays
D 300 mm	<b>Item no.</b>	B 2001 N00 QU	Metal pull-out for metal bay bays

D 250 mm	<b>Item no.</b>	B 2003 M00 QU	Wooden pull-out for wooden bay bays
D 300 mm	<b>Item no.</b>	B 2003 N00 QU	Wooden pull-out for wooden bay bays

## Wooden shelves

### Wooden shelf with integrated book end supports

veneered wood / plastic coated

1 2

D 250 mm	Item no.	Axle size 1000 mm	Axle size 900 mm	Axle size 750 mm	Axle size 500 mm
		B 2124 MW0 QU	B 2124 MU0 QU	B 2124 MS0 QU	B 2124 MR0 QU

### Wooden shelf with book stop and integrated book end supports

veneered wood / plastic coated

1 2

D 250 mm	Item no.	Axle size 1000 mm	Axle size 900 mm	Axle size 750 mm	Axle size 500 mm
		B 2125 MW0 QU	B 2125 MU0 QU	B 2125 MS0 QU	B 2125 MR0 QU

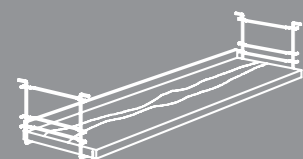

## End Panels

### End panels from perforated sheet metal

As front-side bay finish for hanging in supporting frame with a bay depth of 250 mm.

One side cover per bearing frame is required for single-sided bays, two side covers for double-sided bays.

Individual equipping with accessories for media presentation  
See also Schulz Shelving Systems Accessory Catalogue

Lacquered metal

For bay height

H 1100 mm	Item no.	B 8810 GMR QU	Round holes RG 5/25
H 1500 mm	Item no.	B 8810 CMR QU	Round holes RG 5/25
H 1750 mm	Item no.	B 8810 AMR QU	Round holes RG 5/25
H 2050 mm	Item no.	B 8810 DMR QU	Round holes RG 5/25

For shelf depth 300 mm = N (D 630 mm) the M in the item no. is replaced by an N.

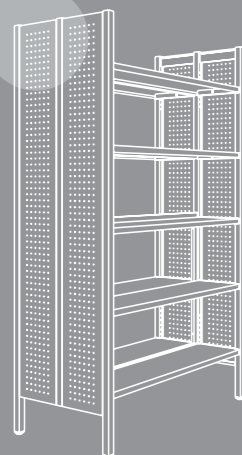

For bay height

H 1100 mm	Item no.	B 8810 GMQ QU	Square holes QG 10/62,5
H 1500 mm	Item no.	B 8810 CMQ QU	Square holes QG 10/62,5
H 1750 mm	Item no.	B 8810 AMQ QU	Square holes QG 10/62,5
H 2050 mm	Item no.	B 8810 DMQ QU	Square holes QG 10/62,5

For shelf depth 300 mm = N (D 630 mm) the M in the item no. is replaced by an N.

## Display Stand

### Display Stand

For individual equipping with accessories on both sides of shelf fronts such as hanging baskets, newspaper holders, book stands, front-side shelves, slanted boards etc., see also Schulz Shelving Systems Accessory Catalogue; Lacquered metal; with 4 lockable wheels; W 568 mm, D 460 mm

H 1560 mm	Item no.	B 7010 CM0 QU	QUADRA-F
H 1810 mm	Item no.	B 7010 AM0 QU	QUADRA-F (see drawing)

H 1560 mm	Item no.	B 7011 CM0 QU	QUADRA-Q
H 1810 mm	Item no.	B 7011 AM0 QU	QUADRA-Q

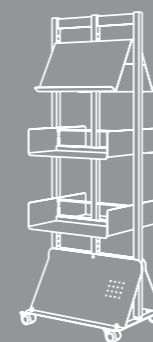

### Display stand for newspapers

Same description as display stand, but with newspaper holders, model ZHK equipped

H 1560 mm	Item no.	B 7010 CM1 QU	QUADRA-F with 8 newspaper holders
H 1810 mm	Item no.	B 7010 AM1 QU	QUADRA-F with 10 newspaper holders (see drawing)

H 1560 mm	Item no.	B 7011 CM1 QU	QUADRA-Q with 8 newspaper holders
H 1810 mm	Item no.	B 7011 AM1 QU	QUADRA-Q with 10 newspaper holders

### Display stand with slanted shelves

Same description as display stand, but with slanted shelves 60°, model SAB 60 equipped

H 1560 mm	Item no.	B 7010 CM2 QU	QUADRA-F with 6 slanted shelves (see drawing)
H 1810 mm	Item no.	B 7010 AM2 QU	QUADRA-F with 8 slanted shelves

H 1560 mm	Item no.	B 7011 CM2 QU	QUADRA-Q with 6 slanted shelves
H 1810 mm	Item no.	B 7011 AM2 QU	QUADRA-Q with 8 slanted shelves

### Display stand with slanted shelves and front-side shelves

Same description as display stand, but with slanted shelves 60°, model SAB 60 and front-side shelves, model STFB equipped

H 1560 mm	Item no.	B 7010 CM3 QU	QUADRA-F with 2 slanted bays & 4 front-side shelves (see drawing)
H 1810 mm	Item no.	B 7010 AM3 QU	QUADRA-F 2 slanted bays and 6 front-side shelves

H 1560 mm	Item no.	B 7011 CM3 QU	QUADRA-Q with 2 slanted bays and 4 front-side shelves
H 1810 mm	Item no.	B 7011 AM3 QU	QUADRA-Q with 2 slanted bays and 6 front-side shelves

## Signage

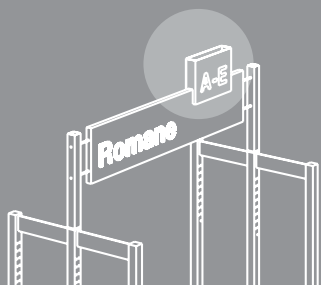
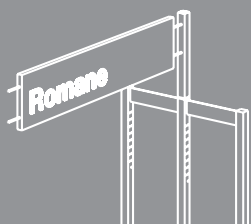

### Signage for starter bays

Labeling frame will be put on bearing frame of single- and double-sided bays.

Labeling Services see also Schulz Shelving Systems Accessory Catalogue.

Two put-on pipes H 300 mm, lacquered metal.

Wooden frame H 180 mm veneered / plastic-coated



	Axle size 1000 mm (W 850 mm)	Axle size 900 mm (W 750 mm)	Axle size 750 mm (W 600 mm)
<b>Item no.</b>	B 8101 GW0 QU	B 8101 GU0 QU	B 8101 GS0 QU

### Signage for add-on bays

Description as above, but only one put-on pipe.



	Axle size 1000 mm (W 850 mm)	Axle size 900 mm (W 750 mm)	Axle size 750 mm (W 600 mm)
<b>Item no.</b>	B 8101 AW0 QU	B 8101 AU0 QU	B 8101 AS0 QU

### Put-on sign

Will be put on labeling frame; allows additional accentuation.

Labeling Service see Schulz Shelving Systems Accessory Catalogue.

Two put-on signs will be needed for double-sided bays which can be combined into one double-sided sign (see drawing).

W 300 mm, D 40 mm, H 150 mm, overlap to the top 100 mm

Lacquered metal

<b>Item no.</b>	B 8102 000 XX
-----------------	---------------

## Description of System

Shelving system with framework construction for storing books, magazines and other printed media, as well as all other non-book media.

Bearing frames from square tubes, 30x30 mm, perforated interior bay sides for tool-free adjustment of shelves with a 25 mm grid module.

Depth connectors are available either as 4 mm-thick metal plates or design pre-fab parts from flat metal.

Support feet equipped with leveling screws.

Longitudinal strut-bracing for bays by diagonal traverses, individually screwed for each shelving section,

Back panels upon request.

Shelves alternatively from wood or metal.

If desired, wooden shelves also available with chrome-plated, integrated book end supports.

Metal parts are lacquered according to DIN 50942 with a particularly resistant, environment friendly stove-enamel powder coating.

Most of the metal fittings are chrome-plated and therefore have long-term corrosion protection.

Wooden surfaces have an environmental-friendly lacquering or are plastic-coated.

## Cross-Section

Square furniture steel tube 30 x 30 mm

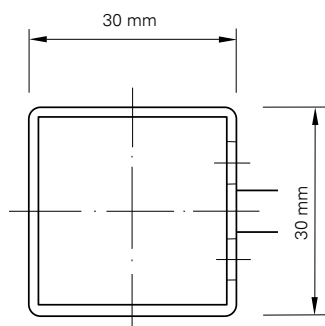

Scale 1:1



Just like the mechanics of a clock where many adjusted parts match with each other, a well thought-out and balanced programme of accessories is vital for the functionality and quality of library furniture.

The following overview will introduce you to our shelving systems for scientific and public libraries.

These systems form the basis for using an extensive and future-oriented range of accessories which we have compiled in this catalogue.

Information on colours and surfaces is in accordance with the SchulzColorRange:

● Colours  
for metal and wood lacquering

■ Surfaces  
wooden or plastic

✱ Materials/cloth  
for seating furniture



**UNIFLEX (UN)**

This classic shelving and organizing system is built as frame construction from square steel bars and stands for proven quality in a timeless design.

UNIFLEX reveals its flexibility in daily use.

The extensive accessories and equipment programme enables an unconditional orientation towards all possible customer requests.

**QUADRA (QU)**

Our system QUADRA has an analogue construction, yet with square profiles, and has also been designed for long-term use in functionality and quality as well as for the very high demands and strains in libraries. You can choose between two different design options which will not only be functional but will set a trend in modern library furniture.

**RONDEA (RO)**

The elegant attitude of our shelving system RONDEA with round steel bars has been coined by reserve and transparency. The filigree construction emphasizes architecture and media. An extensive programme of accessories and two different design options make RONDEA quite adaptable.



## Hangina Book Stops

### Hangina book stop, Model BS 22

For insertion in metal shelves, easily adjustable, round steel, chromed, with unbreakable plastic sliders for an easy and quiet use.  
H 220 mm

#### Fits all systems

For shelf depth 250 mm  
For shelf depth 300 mm

#### Item no.

B 8002 M00 XX  
B 8002 N00 XX

### Hangina book stop, Model BS 28

For insertion in metal shelves with high shelf distances, similar to model BS 22, also suitable for books with extremely large format or very small books through its extra size  
H 280 mm

#### Fits all systems

For shelf depth 250 mm  
For shelf depth 300 mm

#### Item no.

B 8002 M28 XX  
B 8002 N28 XX

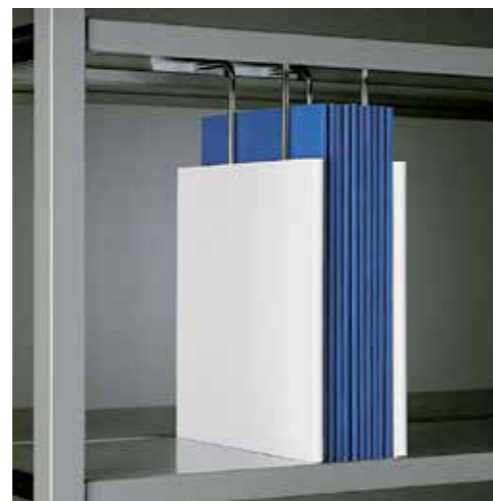

### Divider, Model TS

For sliding upon hanging book stops, model BS 22 and BS 28. The divider lies directly upon the shelves through its own weight and is a valuable accessory part for loose-leaf collections, brochures, music books etc.  
White plastic.  
D 240 mm, H 250 mm

#### Fits all systems

For shelf depth 250 mm and 300 mm  
XX

#### Item no.

B 8005 M00 XX

### Hangina book stop, Model HB 22

For insertion in Multiplex-wooden shelves with guiding grooves for book stops, easily side adjustable, chromed round steel.  
H 220 mm

#### Item no.

UNIFLEX B 8012 000 UN  
QUADRA B 8012 000 QU  
RONDEA B 8012 000 RO

### Hangina book stop, Model BSD 22 BSD 28

For insertion in wooden shelves with guiding rail for book stops, easily adjustable, round steel, chromed.

Item no. H 220 mm H 280 mm

UNIFLEX B 8003 000 UN B 8003 028 UN  
QUADRA B 8003 000 QU B 8003 028 QU  
RONDEA B 8003 000 RO B 8003 028 RO



**Book end stop, Model EP**  
For insertion in metal shelves with high shelf distances, similar to model BS 22, also suitable for books with extremely large format or very small books through its extra size  
H 280 mm

For shelf depth 250 mm

#### Item no.

UNIFLEX B 8006 000 UN  
QUADRA B 8006 000 QU  
RONDEA B 8006 000 RO

## Book End Stops

### Rod as book end stop, Model B 1

For insertion into the perforated holes of the bearing frame, thus variable in height; using two rods on top of each other will perfectly secure books against tipping (see picture), round steel, bright galvanized.

#### Item no.

1 each for	shelves depth 250 mm	shelves depth 300 mm
UNIFLEX	B 8001 M00 UN	B 8001 N00 UN
QUADRA	B 8001 M00 QU	B 8001 N00 QU
RONDEA	B 8001 M00 RO	B 8001 N00 RO

### Book end stop brace, Model DR 2

For insertion into metal shelf boards, chromed round steel.  
H 150 mm

#### Item no.

	shelves depth 250 mm	shelves depth 300 mm
UNIFLEX	B 8007 M00 UN	B 8007 N00 UN
QUADRA	B 8007 M00 QU	B 8007 N00 QU
RONDEA	B 8007 M00 RO	B 8007 N00 RO

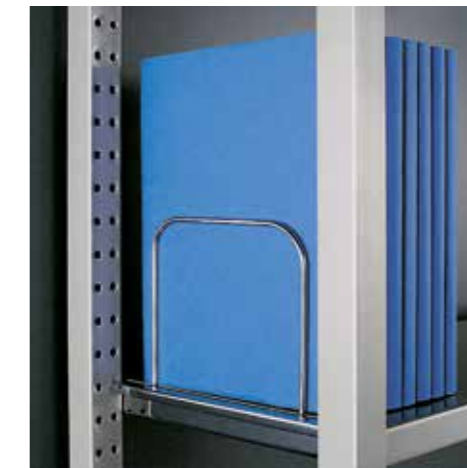

## Angled Book Stops

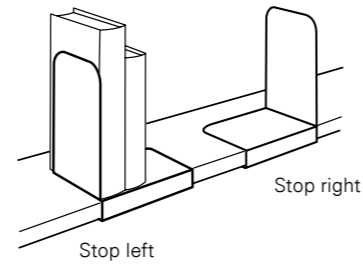

**Angled book stop, Model WB**  
Suitable for all shelving systems, metal – lacquered white or black. W 120 mm, D 80 mm, H 130 mm

**Fits all systems**    **Item no.**  
B 8020 000 XX

**Angled book stop, Model WB 1, WB 2**  
Suitable for all shelving systems, available in two heights, lacquered metal. ● W 120 mm, D 150 mm, H 175/240 mm

**Fits all systems**    **Item no.**  
Height 175 mm    B 8021 010 XX  
Height 240 mm    B 8021 020 XX



**Angled book stop, Model WBG**  
For metal shelves, stop right or left, with front edge and secured fastening for an optimum guiding and for attaching inscriptions. Lacquered metal. ● W 150 mm, D 150 mm, H 200 mm

<b>Fits all systems</b>	<b>Item no.</b>
Stop right	B 8023 00R XX
Stop left	B 8023 00L XX
With inscription, Stop right	B 8023 10R XX
With inscription, Stop left	B 8023 10L XX

**Lettering tag, Model KA/S**  
For later attachment to angled book stops with front edge, transparent plastic, self-adhesive, incl. exchangeable white inscription card. W 147 mm, H 20 mm  
**Schulz** Lettering Service upon request

**Fits all systems**    **Item no.**  
B 8044 201 XX

Blank lettering strips, white, sheet with 13 strips, W 209 mm (shorter sizes by cutting)  
B 8041 000 XX



**Universal angled book stop, Model WBU**  
For metal shelves, can be used left or right simply by turning, both sides with a front edge and secure fastening for optimum guiding, a broad grip edge prevents from unintentional movement of books onto the vertical support side, suitable for horizontal and vertical lettering. ● Lacquered metal. W 175 mm, D 182 mm, H 175 mm

Without lettering tag    **Item no.**  
**Fits all systems**    B 8024 000 XX



## Additional Furnishing for Shelves



**Book stop, Model BA**  
For metal shelves, flexible use, can also be mounted as tilt securing for shelves with projection.  
● Lacquered metal.  
H 24 mm

	Item no.
Axle size 1000 mm	
UNIFLEX	B 8029 0W0 UN
QUADRA	B 8029 0W0 QU
Axle size 900 mm	
UNIFLEX	B 8029 0U0 UN
QUADRA	B 8029 0U0 QU
Axle size 750 mm	
UNIFLEX	B 8029 0S0 UN
QUADRA	B 8029 0S0 QU



**Tilt securing, Model KIS**  
For extractable shelf respectively metal or wooden shelf with projection, prevents the forward tilt of the shelf in the bay; two tilt securings required per shelf, black plastic.

Item no.	1 each
UNIFLEX	B 8070 000 UN
QUADRA	B 8070 000 QU
RONDEA	B 8070 000 RO

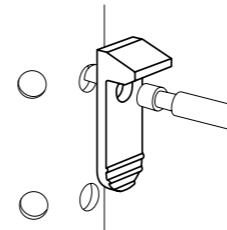

**Shelf reinforcement, Model UZ**  
For metal shelves with extreme shelf, can be easily retrofitted, allows an additional weight of approx. 30 kg per shelf.  
● lacquered metal.

Item no.	Axle size 1000 mm	Axle size 900 mm	Axle size 750 mm
UNIFLEX	B 8071 0W0 UN	B 8071 0U0 UN	B 8071 0S0 UN
QUADRA	B 8071 0W0 QU	B 8071 0U0 QU	B 8071 0S0 QU
RONDEA	B 8071 0W0 RO	B 8071 0U0 RO	B 8071 0S0 RO

**Notes**  
Complete set of metal shelves with pre-inserted board reinforcement.

Board without Book stop	Item no.
	B 2140 ... (.)
Board with Book stop	Item no.
	B 2141 ... (.)

(.) = UN, QU, RO



**Slanting hook, Model SSTH**  
For extractable shelves respectively metal or wooden shelves with projection, prevents the forward tilt of the shelf in the bay; two tilt securings required per shelf, black plastic.

Item no.	1 each
RONDEA	B 8009 000 RO
QUADRA	B 8009 000 QU



**Slanting brace, Model SSTB**  
For variable slanting of shelves with book stop (edge), for display and front presentation; two each slanting braces required per shelf; round steel, bright galvanized.

Item no.	1 each for metal or wooden shelves
UNIFLEX	B 8010 000 UN
QUADRA	B 8010 000 QU
RONDEA	B 8010 000 RO

## Fittings

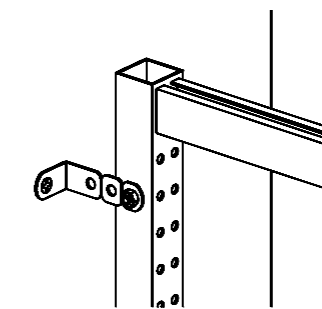

**Wall fastening, Model WBEF**  
For single-sided bays with more than 1100 mm height; bright galvanized metal, incl. fastening kit.  
Wall distance 0 – 40 mm.

Item no.	1 each
UNIFLEX	B 8050 000 UN
QUADRA	B 8050 000 QU
RONDEA	B 8050 000 RO

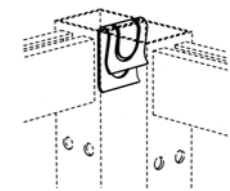

**Connection clamp, Model VBKL**  
For connecting the bearing frames of two adjacent shelving sections, very helpful for extremely high bays or for precise adjustment of the bearing frames, one each is required per shelf connection.  
Bright galvanized metal.

Item no.	1 each
UNIFLEX	B 8052 000 UN
QUADRA	B 8052 000 QU



**Corner connection angle, Model EVW**  
For connecting the bearing frames of two shelving sections across the corner, for an even distance between the shelves. Two each are required per shelf connection. Nickel-plated metal, incl. fastening kit.

Item no.	1 each
UNIFLEX	B 8051 000 UN
QUADRA	B 8051 000 QU

**Tool kit (no picture)**  
For mounting of all Schulz shelving systems, consisting of two fork wrenches SW 10 and three Allan keys of 4, 5 and 7 mm

Item no.	Fits all systems
B 8999 000 XX	

**Adjusting key for feet (no picture)**  
For the adjustment of leveling screws.

Item no.	
UNIFLEX	B 8998 000 UN (SW 28)
QUADRA	B 8998 000 QU (SW 28)
RONDEA	B 8998 000 RO (SW 27)



## Corner Shelves

### Corner shelf for double-sided bays, Model EFD

Wooden shelf for insertion in front side of double-sided bay with a shelf depth of 250 mm, incl. hanging kit, wood veneered/plastic coated. 1 2

Item no.	45° wooden shelf	60° wooden shelf	90° wooden shelf
UNIFLEX	B 2012 M45 UN	B 2012 M60 UN	B 2012 M90 UN
QUADRA	B 2012 M45 QU	B 2012 M60 QU	B 2012 M90 QU
RONDEA	B 2012 M45 RO	B 2012 M60 RO	B 2012 M90 RO



### Corner shelf for double-sided bays, Model EFDR

Wooden shelf with rounded front edge, for insertion in front side of double-sided bays with a shelf depth of 250 mm, incl. hanging kit, wood veneered/plastic coated. 1 2

Item no.	45° wooden shelf round	60° wooden shelf round	90° wooden shelf round
UNIFLEX	B 2013 M45 UN	B 2013 M60 UN	B 2013 M90 UN
QUADRA	B 2013 M45 QU	B 2013 M60 QU	B 2013 M90 QU
RONDEA	B 2013 M45 RO	B 2013 M60 RO	B 2013 M90 RO

### Corner shelf for single-sided bays, Model EF

Wooden shelf for insertion in front sides of single-sided bay with a shelf depth of 250 mm, incl. hanging kit, 1 2 wood veneered/plastic coated.

90° wooden shelf	Item no.
UNIFLEX	B 2010 M90 UN
QUADRA	B 2010 M90 QU
RONDEA	B 2010 M90 RO



### Corner shelf for single-sided bays, Model EFR

Wooden shelf with round front edge, for insertion in front side of single-sided bays with a shelf depth of 250 mm, incl. hanging kit, 1 2 wood veneered/plastic coated.

90° wooden shelf, round	Item no.
UNIFLEX	B 2011 M90 UN
QUADRA	B 2011 M90 QU
RONDEA	B 2011 M90 RO



### Trapezoidal shelf for single-sided bays, Model EFI

Wooden shelf for insertion in the front side of single-sided bays with a shelf depth of 250 mm, with rear book stop (edge) which prevents an unintentional slide-through of the media, incl. hanging kit, 1 2 wood veneered/plastic coated.

90° wooden shelf	Item no.
UNIFLEX	B 2020 M00 UN
QUADRA	B 2020 M00 QU
RONDEA	B 2020 M00 RO

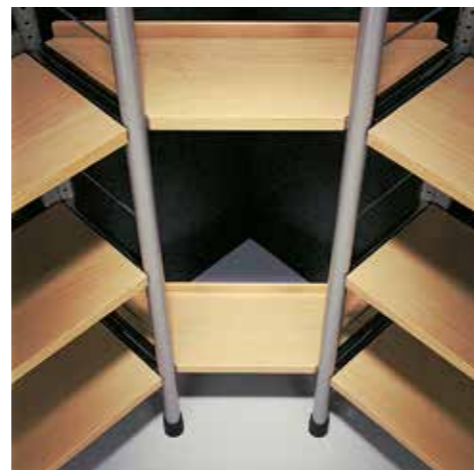

Item no.	for Axle size 1000 mm	for Axle size 900 mm	for Axle size 750 mm
UNIFLEX	B 5510 MW0 UN	B 5510 MU0 UN	B 5510 MS0 UN
QUADRA	B 5510 MW0 QU	B 5510 MU0 QU	B 5510 MS0 QU
RONDEA	B 5510 MW0 RO	B 5510 MU0 RO	B 5510 MS0 RO

**Hanging desk, rectangular, Model EHT/RE**  
Reading and computer desk for insertion in bay sections with a shelf depth of 250 mm, numerous modes of use, desk surface 1 2 wood veneered/plastic coated, incl. hanging kit and tilt securing, lacquered metal feet. D 750 mm, H 725 mm



**Hanging desk, pentagonal, Model EHT/FE**  
Reading desk for insertion in bay sections with a shelf depth of 250 mm, also ideal for small and cramped rooms, desk surface from 1 2 wood veneered/plastic coated, incl. hanging kit and tilt stop, lacquered metal feet. H 725 mm

Item no.	for Axle size 1000 mm, D 793 mm	for Axle size 900 mm, D 743 mm	for Axle size 750 mm, D 668 mm
UNIFLEX	B 5513 MW0 UN	B 5513 MU0 UN	B 5513 MS0 UN
QUADRA	B 5513 MW0 QU	B 5513 MU0 QU	B 5513 MS0 QU
RONDEA	B 5513 MW0 RO	B 5513 MU0 RO	B 5513 MS0 RO



### Hanging desk, round, Model EHT/RU

Reading and computer desk for insertion in front sides of double-sided bays with a shelf depth of 250 mm, desk surface 1 2 wood veneered/plastic coated, incl. hanging kit, lacquered metal feet. Diameter 1000 mm, D 927 mm, H 725 mm

Item no.	
UNIFLEX	B 5501 M00 UN
QUADRA	B 5501 M00 QU
RONDEA	B 5501 M00 RO



## Hanging Tables/Desks

**Hanging desk, drop-shaped, Model EHT/TR**  
Reading and computer desk for insertion in front sides of double-sided bays with a shelf depth of 250 mm when installed as angle 90° combination; offers readers and employees a generous work and display area, desk surface from wood veneered/plastic coated, 1 2 incl. hanging kit, lacquered metal feet. Diameter 1040 mm, H 725 mm

Item no.	
UNIFLEX	B 5500 M00 UN
QUADRA	B 5500 M00 QU
RONDEA	B 5500 M00 RO



## Base Cabinets

### AV media cabinet, Model MS

Base cabinet with four drawers on telescopic full rails, designed for variable organization through mobile dividers, suitable for different AV media. for individual wall placement or for insertion in shelves with an axle size of 900 mm. Lockable upon request and with rail stop which prevents tilting by simultaneous opening of several drawers.

**1 2 3** Wooden body veneered/plastic coated.  
W 865 mm, D 600 mm, H 870 mm

#### Item no.

- B 3495 4U0 (..) with lock, with rail stop (see picture)  
B 3495 4U1 (..) without lock, with rail stop  
B 3495 4U2 (..) without lock, without rail stop  
(for wall mounting)

(..) = UN, QU, RO



### Accessories for drawers in AV media cabinet

For variable set-up of drawers with 4 mobile dividers, grooved rubber mat and 2 threading bars from stainless steel, for 200 CDs with standard cover or 1000 CDs with protective sleeve, or 90 DVDs. Metal dividers, silver lacquered.  
H 80 mm

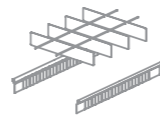

#### Item no.

- B 3516 0U0 (..) 1 set for 1 drawer  
B 3517 000 (..) 1 each additional divider  
(..) = UN, QU, RO

### Base cabinet with swing door, Model USS

Lockable base cabinet with height adjustable shelf, wood veneered/plastic coated. **1 2 3**  
H 870 mm

	Item no.	Item no.
	D 400 mm	D 600 mm
for axle size 1000 mm, W 965 mm,	B 3503 4W0 (..)	B 3504 4W0 (..)
Additional shelf	B 3503 0W0 (..)	B 3504 0W0 (..)
for axle size 900 mm, W 865 mm,	B 3503 4U0 (..)	B 3504 4U0 (..)
Additional shelf	B 3503 0U0 (..)	B 3504 0U0 (..)

(..) = UN, QU, RO

### Base cabinet with sliding doors, Model STS

Lockable base cabinet with height-adjustable shelf, wood veneered/plastic coated. **1 2 3**  
H 870 mm

	Item no.	Item no.
	D 400 mm	D 600 mm
for axle size 1000 mm, W 965 mm,	B 3501 4W0 (..)	B 3502 4W0 (..)
Additional shelf	B 3501 0W0 (..)	B 3502 0W0 (..)
or axle size 900 mm, W 865 mm,	B 3501 4U0 (..)	B 3502 4U0 (..)
Additional shelf	B 3501 0U0 (..)	B 3502 0U0 (..)

(..) = UN, QU, RO

## Reading and Pull-out Shelves



### Reading and presentation shelf, semicircular, Model ALL

Wooden shelf for insertion in shelving sections with axle size 500 mm and a shelf depth of 250 mm, incl. hanging kit and tilt stops, wood veneered/plastic coated. **1 2**  
Axle size 500 mm, D 480 mm

	Item no.
UNIFLEX	B 2729 MR0 UN
QUADRA	B 2729 MR0 QU
RONDEA	B 2729 MR0 RO



### Front-side reading and presentation shelf, semicircular, Model ALS

Wooden shelf for insertion in front side of double-sided bay with a shelf depth of 250 mm, easily retrofitted, incl. hanging kit and tilt stops, wood veneered/plastic coated. **1 2**  
W 525 mm, D 500 mm

	Item no.
UNIFLEX	B 2033 M00 UN
QUADRA	B 2033 M00 QU
RONDEA	B 2033 M00 RO



### Folding board, Model FK

For attachment at front sides of double-sided bays, easy folding for reading, easily retrofitted, lacquered metal. ●  
Incl. fastening kit.  
W 520 mm, D 300 mm

	Item no.
For attachment on wooden panels	
UNIFLEX	B 2041 000 UN
QUADRA	B 2041 000 QU

For attachment on shelf bearing frame W 530	
UNIFLEX	B 2031 0M0 UN
QUADRA	B 2031 0M0 QU

For attachment on shelf bearing frame W 630	
UNIFLEX	B 2031 0N0 UN
QUADRA	B 2031 0N0 QU



### Pull-out shelf, Model FAZ

On hidden telescopic full rails, for installation under metal or wooden shelves from axle size 750 mm upwards, width 600 mm, incl. installation kit and tilt stops, lacquered metal. ●

	Item no.	Item no.
For bearing shelves	wood	metal
Pull-out depth 245 mm, front edge flush with bearing shelf		
For bearing shelf D 250 mm	B 2006 M00 (..)	B 2000 M00 (..)
For bearing shelf D 300 mm	B 2006 N00 (..)	B 2000 N00 (..)
Pull-out depth 295 mm, front edge protruding 50 mm over bearing shelf, easier identification as pull-out shelf shelf.		
For bearing shelf D 250 mm	B 2007 M00 (..)	B 2001 M00 (..)
For bearing shelf D 300 mm	B 2007 N00 (..)	B 2001 N00 (..)

(..) = UN, QU, RO



**Drawer seat, Model SIK**

For use in and insertion in shelving sections, on wheels; with removable, upholstered seat, suitable as storage space. Wood beech multiplex. D 570 mm, H 275 mm

Item no. for Axle size 1000 mm	for Axle size 900 mm	for Axle size 750 mm
<b>UNIFLEX</b> B 8420 0W0 UN	B 8420 0U0 UN	B 8420 0S0 UN
<b>QUADRA</b> B 8420 0W0 QU	B 8420 0U0 QU	B 8420 0S0 QU
<b>RONDEA</b> B 8420 0W0 RO	B 8420 0U0 RO	B 8420 0S0 RO

**Presentation grid, straight, Model GISE**

For attachment to front of double-sided bays with a shelf depth of 250 mm, as bearing system for presentation elements and an inscription shelf, chromed round steel, incl. fastening material. W 490 mm, H 1750 mm

With four bearing clamps

Item no.
<b>RONDEA</b> B 8200 000 RO

With two connection clips

B 8200 000 (.)
----------------

(.) = UN, QU

**Presentation grid, angle shaped, Model GISE/W**

Similar to Model GISE but with expanded, angle-shaped presentation space. W 490 mm, D 522 mm, H 1750 mm

With four bearing clamps and two connection clips

Item no.
<b>RONDEA</b> B 8201 000 RO

**Functional Sides**

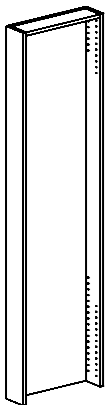

**Functional sides, Model FS 1**

Either as front side finish or for wall mounting. The functional sides can be individually combined with different equipment for lettering and presentation. They have a signal effect and are ideal for the display and presentation of news or event calendars in folder format. Lettering and inscription can be done directly on the functional side or an additional inscription board.

Wood veneered/plastic coated incl. fastening kit. 1 2 3

Functional side	For wall mounting	For UNIFLEX, QUADRA
	B 528 mm	W 528 mm (as side panel)
For bay height	<b>Item no.</b>	<b>Item no.</b>
H 1100 mm	B 8250 GM0 XX	B 8250 GM0 UN,QU
H 1500 mm	B 8250 CM0 XX	B 8250 CM0 UN,QU
H 1750 mm	B 8250 AM0 XX	B 8250 AM0 UN,QU
H 2050 mm	B 8250 DM0 XX	B 8250 DM0 UN,QU
H 2250 mm	B 8250 EM0 XX	B 8250 EM0 UN,QU

For shelf depth 300 mm = N (B 640/628 mm) the M in the item no. will be replaced by an N.

**Inscription shelf, Model BT 1**

For a colour emphasis and for information. Wood veneered/plastic coated incl. fastening kit. W 489 mm, H 368 mm. Schulz Lettering Service upon request

**Item no.** B 8260 0M0 XX **Fits all systems**

For shelf depth 300 mm = N (B 589 mm) the M of the item no. will be replaced by an N.



**Folder rack, Model FL 1**

For an organized presentation of folders. With acrylic glass front, H 120 mm and three removable dividers. Shelf width 115 mm, Wood veneered/plastic coated. W 489 mm, H 140 mm

**Item no.** B 8262 0M0 XX **Fits all systems**

For shelf depth 300 mm = N (B 589 mm) the M in the item no. will be replaced by an N.

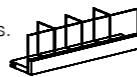

**Display shelf, Model PT 1**

For the presentation of media and for colour emphasis. Lacquered metal. W 489 mm, H 255 mm

**Item no.** B 8261 0M0 XX **Fits all systems**

For shelf depth 300 mm = N (B 589 mm) the M of the item no. will be replaced by an N.

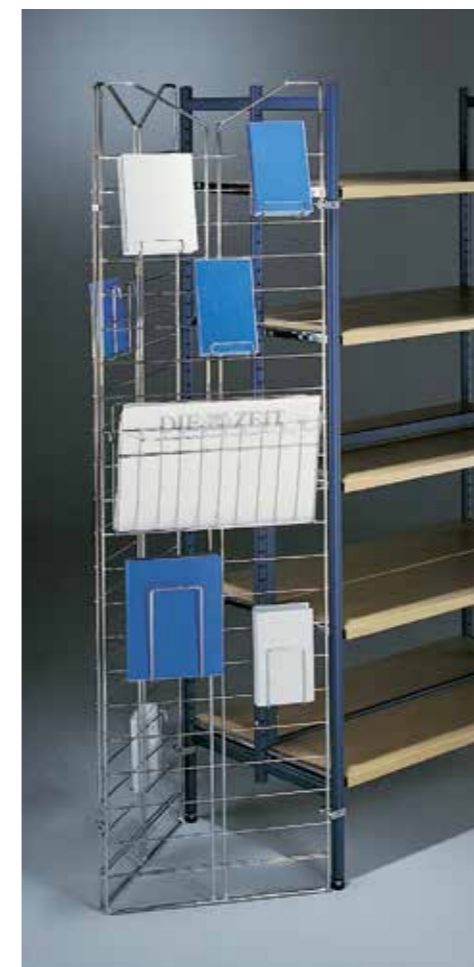
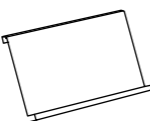

**Inscription board, Model BSGI (see left picture)**

Easy fixing on presentation grid, as sign post and orientation aid, beech multiplex. W 400 mm, H 284 mm

**Item no.** B 8202 000 (.)

(.) = UN, QU, RO



**Hanging metal display, Model ZFVH**  
 For insertion in presentation grid, side panels from perforated sheet metal with round holes RG 5/25, square holes QG 10/62.5 and slot holes 4/40, as well as two holding rods Model B 1 also for direct insertion in shelf front sides, W 90 mm, H 200 mm, insert size up to 50 mm, chromed metal.

**Item no.**  
**Fits all systems** B 8211 000 XX



**Book presenter, Model BAH 5**  
 For placing or hanging in presentation grid, side panels from perforated sheet metal with round holes RG 5/25, square holes QG 10/62.5 and slot holes 4/40, as well as two holding rods Model B 1 also for direct insertion in shelf front sides, for German DIN A4 formats such as paperbacks, video cassettes etc., chromed metal.

**Item no.**  
**Fits all systems** B 8210 000 XX



**Holding/bearing rod, Model B 1**

As holder for front-side presentation elements, for insertion into grid systems of the bearing frame, easily height adjustable, bright galvanized round steel.

**Item no.**  
 1 each for shelf depth 250 mm  
**UNIFLEX** B 8001 M00 UN  
**QUADRA** B 8001 M00 QU  
**RONDEA** B 8001 M00 RO

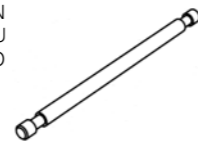

For shelf depth 300 mm = N the M in the item no. will be replaced by an N.

**Book Presentation**

**Slanted shelf 60°, Model SAB 60**

For the presentation of books, magazines etc., For hanging in presentation grid and front sides of double-sided shelves.  
 ● Lacquered metal, incl. hanging kit.  
 W 469 mm, D 290 mm

**Item no.**  
**UNIFLEX** B 8222 0M0 UN  
**QUADRA** B 8222 0M0 QU  
**RONDEA** B 8222 0M0 RO  
**PRESENT.GRID** B 8222 0M0 GI



**Front-side shelves, Model STFB**  
 For hanging into presentation grids and front sides of double-sided bays, for books (see pic.1), with additional CD shelf rack B 8500 003 XX (see page 27) also suitable for ● 42 CDs (see pic.2), lacquered metal, incl. hanging kit.  
 W 469 mm, D 250 mm, H 120 mm

**Item no.**  
**UNIFLEX** B 8221 0M0 UN  
**QUADRA** B 8221 0M0 QU  
**RONDEA** B 8221 0M0 RO  
**PRESENT.GRID** B 8221 0M0 GI



**Book Presentation**



**Book manger, Model BT 2**  
 With slanted shelf for front or book spine presentation of different media, for hanging in presentation grids and front sides of double-sided bays, insertion width/depth up to 450/200 mm, incl. hanging kit, beech multiplex.  
 W 480 mm, D 260 mm, H 205 mm

**Item no.**  
**UNIFLEX** B 8216 2W0 UN  
**QUADRA** B 8216 2W0 QU  
**RONDEA** B 8216 2W0 RO  
**PRESENT.GRID** B 8216 2W0 GI



**Paperback box, Model TBT 2**  
 For hanging in presentation grids and front sides of double-sided bays, insertion width/depth up to 450/150 mm, incl. hanging kit, beech multiplex.  
 W 480 mm, D 183 mm, H 150 mm

**Item no.**  
**UNIFLEX** B 8215 2W0 UN  
**QUADRA** B 8215 2W0 QU  
**RONDEA** B 8215 2W0 RO  
**PRESENT.GRID** B 8215 2W0 GI



**CD and paperback holder, Model CDH**  
 For hanging in perforated sheet metal panels with round holes RG 5/25 and slot holes 4/40, bright galvanized metal, variable width, insert size up to 25 mm, H 60 mm. Picture shows on pair

**Item no.**  
**Fits all systems** B 8209 000 XX on pair



**Comic and map box, Model CTR**  
 For hanging in shelving sections with a shelves depth of 250 mm, allows user to easily flip through media with simultaneous front presentation, variable set-up through mobile dividers, also suitable for videos and DVDs, grooved rubber mat, hanging kit and tilt stops.  
 D 376 mm, H 200 mm

**Item no.**  
 for axle size 1000 mm, incl. 3 dividers for ca. 136 comics B 8602 MW0 (. .)  
 for axle size 1000 mm, incl. 5 dividers for ca. 162 maps B 8602 MW1 (. .)  
 for axle size 900 mm, incl. 2 dividers for ca. 102 comics B 8602 MU0 (. .)  
 for axle size 900 mm, incl. 4 dividers for ca. 135 maps B 8602 MU1 (. .)  
 (. .) = UN, QU, RO

**Item no.**  
 1 each additional divider for Comic and map box B 8603 000 (. .)  
 (. .) = UN, QU, RO



**Broadside box (Querbox ©) for magazines in shelves, Model ZQB**

For storing of magazines in bays with 250 mm shelf depth. When opened, the display flap for the current issue can be pushed in for easy handling. An additional, transparent antireflex foil allows presentation of a front page for easy identification of the chosen issue.

Magazines are stored broadside in this box with the advantage that the magazine spines can be seen from the front and that the magazines are stored with more care, compared to boxes with standing magazines, and they can easily be taken out. Stacking height 140 mm, max. magazine size W 230 mm, H 315 mm. Box and flap made of lacquered metal, max. 3 each on shelf boards with axle size 1000 mm. W 320 mm, D 260 mm, H 320 mm

**Item no.**  
**Fits all systems** B 8311 000 XX

**Other models:**

**Magazine box, Model ZBV, (no picture)**

Upright storage of magazines on shelf depth 250 mm. With adjustable back. Stacking height 140 mm, max. magazine size W 230 mm, H 310 mm. Box and flap made of lacquered metal, max. 4 each on shelf with axle size 1000 mm. W 238 mm, D 260 mm, H 320 mm

**Item no.**  
**Fits all systems** B 8310 000 XX

**Magazine box, Model ZBL, (no picture)**

Broadside storage of magazines on board depth 300 mm and above. Stacking height 140 mm, max. magazine size W 230 mm, H 310 mm. Box and flap made of lacquered metal, max. 4 each on shelf with axle size 1000 mm. W 238 mm, D 340 mm, H 320 mm

**Item no.**  
**Fits all systems** 0 3016 010



**Sectioned shelf, Model MB**

For insertion in shelving section with axle size 1000 mm and a shelf depth of 300 mm, for horizontal display and storage of magazines in German DIN A4 format (see picture 1), randomly expandable with slanted shelves (see picture 2), lacquered metal, incl. dividers for four rows of magazines. D 300 mm, H 150 mm

for axle size 1000 mm  
**Item no.**  
**UNIFLEX** B 2060 NWO UN  
**QUADRA** B 2060 NWO QU  
**RONDEA** B 2060 NWO RO



**Slanted shelf board, Model ZF 3**

For insertion shelving section with axle size 1000 mm and a shelf depth of 300 mm, for presenting the recent issue of magazines brochures etc., lacquered metal, incl. hanging kit. D 300 mm

**Item no.**  
**UNIFLEX** B 2611 NWO UN  
**QUADRA** B 2611 NWO QU  
**RONDEA** B 2611 NWO RO



**Connectable magazine collector, Model ZSSA**

Slanted magazine sections for storing current brochures, pamphlets, forms, etc. randomly connectable side by side through plug-in connections, max. 9 each on axle size 1000 mm, max. 8 each on axle size 900 mm, max. 6 each on axle size 750 mm, lacquered metal. Single element: W 95 mm, D 240 mm, H 300 mm

**Item no.**  
**Fits all systems** B 8026 000 XX



**U-support, Model UST**

Multiple uses, p.e. for loose-leaf collections, music books etc., lacquered metal. W 145 mm, D 220 mm, H 250 mm

**Item no.**  
**Fits all systems** B 8027 000 XX

**Magazine Presentation**

**Magazine presenter, Model ZSA**

A slanted back and an additional side stop are a very organized way of presenting single magazine stacks in shelves with a shelf depth of more than 250 mm. The binder or folder will be placed flush with the front edge which has a double reinforced edging. For use with metal shelves, we have included an additional slip stop to the front.

Lacquered metal, back height 300 mm, depth of storage area 80 mm.

**Item no.**  
**Fits all systems** B 8025 A40 XX German DIN A4, width 220 mm, max. 4 each  
 On shelves axle size 1000 mm

**Fits all systems** B 8025 A30 XX German DIN A3, width 440 mm, max. 2 each  
 On shelves axle size 1000 mm





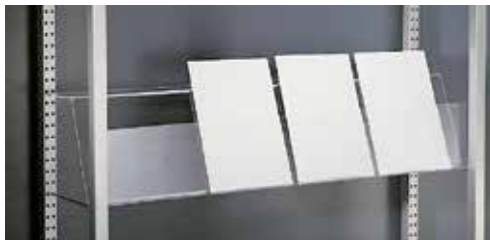

**Brochure shelf, Model BRF**

For insertion in shelving section with a shelf depth of 250 mm, for the presentation of pamphlets, magazines, brochures etc., highly transparent acrylic glass with upward front edge H 160 mm, incl. hanging kit. D 232 mm, H 220 mm

Item no.	For axle size 1000 mm	For axle size 900 mm	For axle size 750 mm
<b>UNIFLEX</b>	B 2050 0W0 UN	B 2050 0U0 UN	B 2050 0S0 UN
<b>QUADRA</b>	B 2050 0W0 QU	B 2050 0U0 QU	B 2050 0S0 QU
<b>RONDEA</b>	B 2050 0W0 RO	B 2050 0U0 RO	B 2050 0S0 RO



**Plastic insert, Model ZF/EIN**

For placement on slanted shelves with book stop and a shelf depth of 300 mm, has a 60 mm high edge and is ideal for storing newspaper or magazine stacks as well as thick books, allows the display of front pages as orientation aid, highly transparent acrylic glass. D 296 mm, H 60 mm

Item no.	For axle size 1000 mm	For axle size 900 mm	For axle size 750 mm
<b>Fits all systems</b>	B 8321 NW0 XX	B 8321 NU0 XX	B 8321 NS0 XX



**Transparent foil, Model ZFF**

For placement on slanted shelves with book stop and a shelf depth of 300 mm, allows the display of front pages as orientation aid, highly transparent acrylic glass. Axle size 1000 mm, D 295 mm (shorter sizes by cutting)

Item no.	For axle size 1000 mm
<b>Fits all systems</b>	B 8322 0W0 XX

**Universal hanging cage, Model UEKB**

Use as book stand (see pic.1), display shelf (see pic.2) or newspaper manger (see pic.3), for hanging in presentation grid and front sides of up to 420 mm, incl. hanging kit, chromed round steel. W 435 mm, D 120/40 mm, H 273 mm

Item no.	Item no.
<b>UNIFLEX</b>	B 8212 000 UN
<b>QUADRA</b>	B 8212 000 QU
<b>RONDEA</b>	B 8212 000 RO
<b>PRESENT.GRID</b>	B 8212 000 GI



**Newspaper holder, Model ZHK**

For newspapers, brochures etc., for hanging in presentation grids and front sides of double-sided bays, incl. hanging kit, highly transparent acrylic glass. W 350 mm, H 260 mm

Item no.	Item no.
<b>UNIFLEX</b>	B 8219 000 UN
<b>QUADRA</b>	B 8219 000 QU
<b>RONDEA</b>	B 8219 000 RO
<b>PRESENT.GRID</b>	B 8219 000 GI

**Newspaper and Magazine Presentation**

**Continuous magazine flap, Model DZK**

You can display three current titles, the previous versions are stored behind – broadside on the shelf. Broadside stacking has the great advantage that all inscriptions and prints on the spine can still be seen from the front. An effective lever mechanism supports the comfortable handling and keeps the lifted flap open. Easily retrofitted for single- and double-sided bays with axle size 1000 mm and a shelf depth of 250 mm. In order to prevent a slip-through to the back, we recommend using shelves with backs. Shelves H 2250 mm can be equipped with max. 6 flaps high. Stacking height for German DIN A4: 160 mm.

- Flap and sides from lacquered metal, W 961 mm, H 340 mm, without shelf

Item no.	Item no.
<b>UNIFLEX</b>	B 8315 MW0 UN
<b>QUADRA</b>	B 8315 MW0 QU



1



2



3

**Slanted display 60° shelf, Model SAB 60**

For displaying books, magazines etc., for hanging in presentation grids and front sides of double-sided shelves, ● lacquered metal, incl. hanging kit. W 469 mm, T 290 mm

Item no.	Item no.
<b>UNIFLEX</b>	B 8222 0M0 UN
<b>QUADRA</b>	B 8222 0M0 QU
<b>RONDEA</b>	B 8222 0M0 RO
<b>PRESENT.GRID</b>	B 8222 0M0 GI



**Plastic magazine collector, Model ZESA**

Helpful for the storage of brochures, pamphlets, loose-leaf collections etc., with front-side edge for guiding along the shelf board and for attaching inscriptions, light grey plastic. W 80 mm, D 230 mm, H 325 mm

Item no.	Item no.
<b>Fits all systems</b>	B 8313 000 XX 1 each





**LED presentation board**

Are you proud of your new acquisitions, or would you like to present different types of media on one specific topic? Our LED presentation board offers you the appropriate frame. It has a perforated metal front which can be equipped and individually combined with all kinds of presentation accessories.

State-of-the-art LED technology will definitely attract the visitors' attention, with a minimum of electricity consumption and extreme durability.

This LED presentation board is also well suitable to brighten up some less frequented dark corners, niches and hallways.

Comes with 29 LEDs, ready for operation, incl. plug and cable for 250V socket.

Perforated sheet metal, lacquered; with put-on sign for lettering upon request.

**LED presentation board without accessories**

W 870 mm, D 60 mm, H 1650 mm

Item no. B 7706 AU0 XX

**LED presentation board without accessories**

W 870 mm, D 60 mm, H 1950 mm

Item no. B 7706 DU0 XX

**Sign**

Lacquered metal, W 300 mm, D 40 mm, H 150 mm

Schulz Lettering Service upon request

Item no. B 8102 000 XX

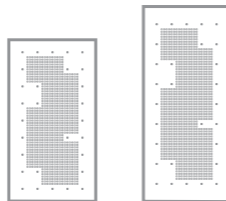

**Presenting Digital Media**



**Sign**

Lacquered metal, W 300 mm, D 40 mm, H 150 mm

Schulz Lettering Service upon request

Item no. B 8102 000 XX

**CD Display wall**

Is ideal for presenting small media. This display wall will show your CDs and CD-ROMs at their best and give the user an optimum access to your "Top 10" or other groups and subjects like no other piece of furniture.

The CD display is available either for individual mounting on wooden bases or in different widths already installed on a wall board.

If desired, a sign with inscription will attract additional attention.

CD display: lacquered metal,

Wooden wall board veneered/plastic coated. 1 2 3

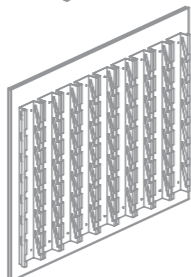
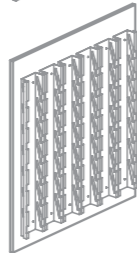
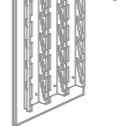
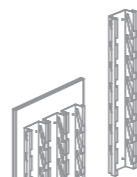

**CD Display**

For individual mounting on wooden bases such as side panels, cabinet sides etc., incl. fastening material, for 7 CDs, W 148 mm, D 50 mm, H 900 mm

Item no. B 7711 000 XX

**CD display wall**

For wall mounting incl. fastening material and CD display for a total of 21 CDs (see drawing). W 550 mm, D 89 mm, H 1100 mm

Item no. B 7710 003 XX

**CD display wall**

For wall mounting incl. fastening material and 6 CD displays for a total of 42 CDs. W 1000 mm, D 89 mm, H 1100 mm

Item no. B 7710 006 XX

**CD display wall**

For wall mounting incl. fastening material and 9 CD display for a total of 63 CDs. W 1450 mm, D 89 mm, H 1100 mm

Item no. B 7710 009 XX

	Item no.	Item no.
For shelf depth 250	Axle size 1000 Incl. 5 dividers for approx. 180 CDs	Axle size 900 incl. 4 dividers for approx. 150 CDs
	<b>UNIFLEX</b> <b>QUADRA</b> <b>RONDEA</b>	<b>B 8600 MU0 UN</b> <b>B 8600 MU0 QU</b> <b>B 8600 MU0 RO</b>
		<b>B 8600 MU0 UN</b> <b>B 8600 MU0 QU</b> <b>B 8600 MU0 RO</b>

For shelf depth 300 mm  
the M in the item no. will be replaced by an N.

**Fits all systems** B 8601 000 (.) 1 each additional divider  
(.) = UN, QU, RO



**AV media tray, Model MEHT**

For hanging in bays with a shelf depth of 250 and 300 mm. allows user to easily flip through media with simultaneous front presentation. Variable management through mobile dividers, suitable for different types of AV media, tray and dividers from lacquered metal, wooden sides veneered/plastic coated, incl. grooved rubber mat, threading bars, hanging kits and tilt stops.

D 376 mm, H 100 mm, tray height 80 mm

**Multimedia browser as top shelf (see picture), Model MMW**

For an organized and space-saving storage of CDs, CD-ROMs, DVDs, videos or cassettes in shelves.

Allows user to easily flip through media with simultaneous front presentation. Variable management by mobile dividers. browser made of lacquered metal,

for fixing on wooden and metal shelves. Depth 250 mm without book stop. Browser height 100 mm, Incl. grooved rubber mat.

	Item no.	Item no.
<b>Fits all systems</b>	Axle size 1000 Incl. 5 dividers for approx. 120 CDs/DVDs with standard cover	Axle size 900 incl. 4 dividers for approx. 100 CDs/DVDs with standard cover
	<b>B 8620 MW1 XX</b>	<b>B 8620 MU1 XX</b>
<b>Fits all systems</b>	B 8621 M00 XX 1 each additional divider	

**Multimedia browser for insertion (no picture), Model MMWE**

Same description as above, but with side consoles for direct insertion in bays with a shelf depth of 250 mm.

	Item no.	Item no.
<b>Fits all systems</b>	Axle size 1000 B 8620 MW2 (.)	Axle size 900 B 8620 MU2 (.)
		(.) = UN, QU, RO
<b>Fits all systems</b>	B 8621 M00 XX 1 each additional divider	



**Pull-out multimedia browser (see picture), Model MMWA**

Several browsers can be placed on top of each other by a telescopic full rail in order to save room in a bay with board shelf 250 mm. An additional handle makes the user aware of this pull-out function.

Same description as above, but with side consoles, pull-outs, handle and tilt stops.

	Item no.	Item no.
<b>Fits all system</b>	Axle size 1000 B 8620 MW0 (.)	Axle size 900 B 8620 MU0 (.)
		(.) = UN, QU, RO
<b>Fits all system</b>	B 8621 M00 XX 1 each additional divider	
<b>B 8623 000 XX</b>	1 each DVD-rest for clipping onto the rear perforated row for heightening the back panel. If requested, one is required per DVD row.	

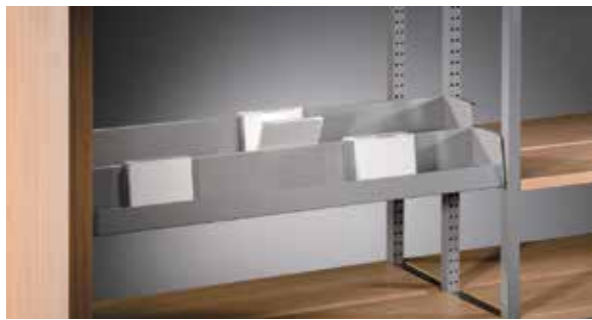

Multimedia stair, connectable, 2 steps



Multimedia stair, connectable, 3 steps

**Multimedia stair, connectable, Model MMT**

Flexible solution for room-saving storage of CDs, CD-ROMs or DVDs in shelves with shelf depth 250 mm. The stair can be placed single or double – and also triple on top of each other in front of the shelf. A slight slanting gives you an ideal view and you can easily reach the media. This system is a perfect supplement for the pull-out multimedia browser or the AV media tray, if placed single or double on top of these. Browser from lacquered metal, incl. hanging kit ●  
D 110 mm, height of front edge 50 mm

For front presentation	Axle size 1000 mm for approx. 60 CDs	Axle size 900 mm for approx. 60 CDs
<b>Item no.</b>	B 8510 MW0 (. .) 1 each	B 8510 MU0 (. .) 1 each
Grooved rubber mat for multimedia stair		
<b>Item no.</b>	B 8511 MW0 (. .)	B 8511 MU0 (. .)
	(. .) = UN, QU, RO	

**Multimedia browser, Model MMK**

CDs, CD-ROMs, DVDs and also videos can be stored by either presenting their title or side by side presenting their back. Both arrangements can be ideally seen and handled because the browser has a slanted position. For large stocks of media, this multimedia browser is an ideal supplement for the pull-out multimedia browser or our AV media tray which will be inserted in the shelves. ● Browser from lacquered metal, incl. hanging kit.  
D 165 mm, edge height 140 mm

For shelf depth D 250 mm	Axle size 1000 mm	Axle size 900 mm
For front presentation	For approx. 90 CDs	For approx. 90 CDs
For back presentation	For approx. 95 CDs	For approx. 85 CDs
<b>Item no.</b>	B 2080 MW0 (. .)	B 2080 MU0 (. .)
	(. .) = UN, QU, RO	



**Presenting Digital Media**

**CD and paperback holder, Model CDH**  
For insertion in perforated end panels with round holes RG 5/25 and slot holes 4/40, bright galvanized steel wire, variable width. Insertion strength up to 25 mm, H 60 mm

<b>Fits all systems</b>	<b>Item no.</b> B 8209 000 XX
-------------------------	----------------------------------



**Presentation tray, Model TRK 2**

With 2 dividers for approx. 60 CDs, for insertion in presentation grids and also front sides of double-sided bays, beech multiplex, incl. five dividers, grooved rubber mat and hanging kit. W 480 mm, D 285 mm, H 136 mm

<b>UNIFLEX</b>	<b>Item no.</b> B 8213 2W0 UN
<b>QUADRA</b>	B 8213 2W0 QU
<b>RONDEA</b>	B 8213 2W0 RO
<b>PRESENT.GRID</b>	B 8213 2W0 GI

**Shelf for front side, Model STFB**

For hanging in presentation grids and front sides of double-sided bays, for additional CD shelf tops B 8500 003 XX or B 8501 003 XX (see left) lacquered metal, incl. hanging kit. ●  
W 469 mm, D 250 mm, H 120 mm  
**without** CD shelf top

<b>UNIFLEX</b>	<b>Item no.</b> B 8221 0M0 UN
<b>QUADRA</b>	B 8221 0M0 QU
<b>RONDEA</b>	B 8221 0M0 RO
<b>PRESENT.GRID</b>	B 8221 0M0 GI

**CD shelf board top, Model CDA**

Can be easily fixed on metal or wooden shelves with a depth of 250 mm, also suitable for shelves with a book stop edge, allows the user to easily flip through the CDs with simultaneous front presentation, available in designs with two or three rows, and for CDs in standard or protective cover, random placement side by side, chromed round steel.  
W 464/311 mm, D 262 mm, H 40 mm

The following is needed to completely equip a shelf:

For axle size 1000 mm:	2 each, three-rowed
For axle size 900 mm:	1 each, three-rowed, 1 each, two-rowed
For axle size 750 mm:	2 each, two-rowed
For axle size 500 mm:	1 each, three-rowed

**Fits all systems**

1 each, three-rowed, for 42 CDs with standard cover, 10.5 mm thick	<b>Item no.</b> B 8500 003 XX
1 each, two-rowed, for 28 CDs with standard cover, 10.5 mm thick	B 8500 002 XX
1 each, three-rowed, for 30 CDs with protective cover, 18.5 mm thick	B 8501 003 XX
1 each, two-rowed, for 20 CDs with protective cover, 18.5 mm thick	B 8501 002 XX



**Thematic Browser, Model TW 1**

For storing theme-related AV media such as CDs, CD-ROMs, DVDs next to the relevant books. Random placement on shelves or tables/desks. Browser from lacquered metal, with anti-slipping feet. ●  
W 150 mm, D 220 mm, H 120 mm

<b>Fits all systems</b>	<b>Item no.</b> B 8505 000 XX for ca. 20 CDs/DVDs
<b>Fits all systems</b>	B 8506 000 XX grooved rubber mat for thematic browser





## Lights for Shelves

### Horizontal light, Model HL 1

Will be plugged onto the bearing frames of single and double-sided shelves. Also possible for covering two axle sizes without a middle lamp arm. For a hidden cable conduct to the floor, 1 per shelf row for single-sided bays and 2 UNIFLEX light bearing frames for double-sided bays have to be planned (with cable outlet K1). For a central control. Protrusion approx. 300 mm to front edge of lamp, lacquered metal, incl. acrylic cover, ● T8 lamp and electronic ballast. Cannot be combined with doors.

1 basic horizontal light with 2 lamp arms,  
2 front-side covers, cable with mains plug 1.5 m black

Item no.	Item no.	Item no.
Axle size 1000 mm B 8730 1WG UN	Axle size 900 mm B 8730 1UG UN	Axle size 750 mm B 8730 1SG UN

1 add-on horizontal light with 1 lamp arm

Item no.	Item no.	Item no.
Axle size 1000 mm B 8730 1WA UN	Axle size 900 mm B 8730 1UA UN	Axle size 750 mm B 8730 1SA UN

1 basic horizontal light covering two axle sizes continuously



### Halogen shelf light, Model HRL 2

For completely illuminating a shelf and also for accent lights. For single- or double-sided bays: will be plugged on special UNIFLEX light bearing frames (with cable outlet K1) for a hidden cable conduct to the floor. Lamps incl. halogen reflector lamp for voltage 230V/50W and feed line to the base. For central control. Protrusion approx. 300 mm to the front edge of lamp, Lacquered metal. Cannot be combined with doors. ●

Item no.
UNIFLEX B 8700 000 UN 1 Halogen shelf lamp for UNIFLEX light bearing frames

Mains connection and interlinking of lights is made by electric mains and connection cables in the shelf base.

**Connection cable with Schuko plug** incl. distribution coupling for cable conduct in the shelf base, is required 1x per shelf row.

Item no.
UNIFLEX B 8701 000 UN 1 meter, black
UNIFLEX B 8701 003 UN 3 meter, black

**Connection cable** for single- and double-sided bays, Incl. distribution coupling for cable conduct in the shelf base.

Item no.
UNIFLEX B 8702 000 UN standard length for max. Axle size 1000 mm, required 1x per add-on shelf, black

### Vertical light, Model T 5

For installation on the standard bearing frames of single- and double-sided bays. Lights incl. 2 fluorescent tubes 21 W, length 912 mm, electronic ballast and diffuser for perforated plate. We offer outer and middle shelf lights for an optimum light distribution.

- Protrusion approx. 65 mm to the front edge of the lamp, lacquered metal. Cannot be combined with doors or with protruding accessories such as broadside boxes, pull-out multimedia tubs etc.

	Item no.	Item no.	Item no.
	1 outer light left type	1 middle light	1 outer light right type
For bay height 2050 mm	B 8722 D0L UN	B 8722 D0M UN	B 8722 D0R UN
For bay height 2250 mm	B 8722 E0L UN	B 8722 E0M UN	B 8722 E0R UN

Other bay heights upon request.

**Mains connection and interlinking of lights are made by electric mains with triple plugs in the shelf base.**

2 lines are required for double-sided bays, for single-sided starter bays and single- or double-sided add-on bays only one line is required.

Item no.
B 8723 000 XX 1 mains connection and interlinking line

**Our shelving system UNIFLEX offers numerous other possibilities for making lights effective where it is required.**

**Continuous light assemblies with round or square profiles can be installed at different lamp holders and shelf connectors.**





## Signage

### Labelling sign, Model L 3

For marking of sections, simply clip on metal or wooden shelves, incl. exchangeable moisture-proof labelling strips white, labelling sign transparent plastic, antireflex H50 mm. Schulz Labelling Service upon request.



Item no.	for axle size 1000 mm	for axle size 900 mm	for axle size 750 mm	for axle size 500 mm
UNIFLEX	B 8038 0W0 UN	B 8038 0U0 UN	B 8038 0S0 UN	B 8038 0R0 UN

Blank labelling strips white, moisture-proof, for axle size 1000 mm, (shorter sizes by cutting)

Item no. B 8039 0W0 UN

## Front Side Signage



### Inscription triangle, Model DRE

Can be read in row direction, will be hung in the bearing frame as top shelf finish when used as front side labelling, for bay heights above 2200 mm to guarantee the required headroom, incl. exchangeable, moisture-proof labelling strip white, holder lacquered metal, labelling strip transparent plastic, antireflex H 50 mm. Schulz Labelling Service upon request

#### Item no.

For single-sided bays with shelf depth 250 mm  
UNIFLEX B 8087 ME0 UN

For single-sided bays with shelf depth 300 mm  
UNIFLEX B 8087 NE0 UN

#### Item no.

For double-sided bays with shelf depth 250 mm  
UNIFLEX B 8087 MD0 UN

For double-sided bays with shelf depth 300 mm  
UNIFLEX B 8087 ND0 UN

Blank labelling strips white, moisture-proof for shelf depth 250 mm

UNIFLEX B 8088 OM0 UN

Blank labelling strips white, moisture-proof, for shelf board 300 mm

UNIFLEX B 8088 ON0 UN



### Labelling sign, Model K 3

Front side labelling for insertion in the bearing frame as top shelf finish, incl. Exchangeable moisture-proof Labelling strip white, labelling sign Transparent plastic, antireflex. Two labelling signs are required for Double-sided shelves. H 50 mm. Schulz Labelling Service upon request

#### Item no.

1 each for shelf depth 250 mm  
UNIFLEX B 8085 M00 UN

1 each for shelf depth 300 mm  
UNIFLEX B 8085 N00 UN

#### Item no.

Blank labelling strips white, moisture-proof, for shelf depth 250 mm

UNIFLEX B 8086 M00 UN

Blank labelling strips white, moisture-proof, for shelf depth 300 mm

UNIFLEX B 8086 N00 UN

## Labelling Flags



**Labelling flag, Model FA 3**  
For insertion in the outer posts of bearing frames, lacquered metal. W 120 mm, H 120 mm  
● Schulz Labeling Service upon request.

**Item no.**

With transparent plastic cover, incl. labelling cardboard white  
**UNIFLEX** B 8095 00K UN  
**QUADRA** B 8095 00K QU

Without transparent plastic cover with self-stick letters  
**UNIFLEX** B 8095 000 UN  
**QUADRA** B 8095 000 QU

For screwing onto end panels, with transparent plastic cover, incl. labelling cardboard white.  
**UNIFLEX** B 8096 00K UN  
**QUADRA** B 8096 00K QU

For screwing onto end panels, without transparent plastic cover, with self-stick letters  
**UNIFLEX** B 8096 000 UN  
**QUADRA** B 8096 000 QU

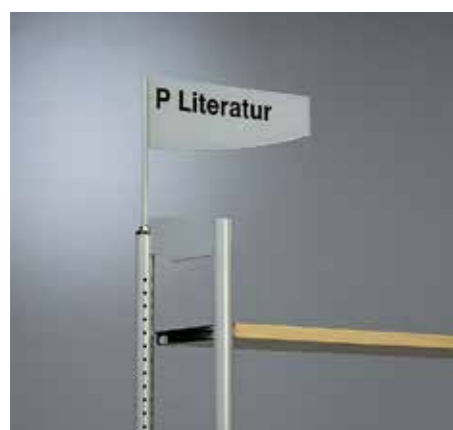

**Metal labelling flag, Model BSFS**  
For insertion in shelf posts, randomly turn; flag and holding rod from lacquered metal, height 300 mm, flag W 400 mm, minimum height 80 mm.  
● Schulz Labeling Service upon request

**Item no.**

**UNIFLEX** B 8099 000 UN  
**QUADRA** B 8099 000 QU  
**RONDEA** B 8099 000 RO

**Labelling flag, Model FA 5**  
For hanging in the outer posts of bearing frames, for German DIN A5 format, lacquered metal. W 210 mm, H 148 mm.  
● Schulz Labeling Service upon request.

**Item no.**

With transparent plastic cover, incl. labelling cardboard white.  
**UNIFLEX** B 8082 A5K UN  
**QUADRA** B 8082 A5K QU

Without transparent plastic cover, with self-stick letters.  
**UNIFLEX** B 8082 A50 UN  
**QUADRA** B 8082 A50 QU

For screwing onto end panels, with transparent plastic cover, incl. labelling cardboard white.  
**UNIFLEX** B 8083 A5K UN  
**QUADRA** B 8083 A5K QU

For screwing onto end panels, without transparent plastic cover, with self-stick letters  
**UNIFLEX** B 8083 A50 UN  
**QUADRA** B 8083 A50 QU

**Holding rod, Model BSHT**  
For insertion in shelf posts, For fixing of up to three metal labelling flags, Model BSFM, bright galvanized metal. H 350 mm.

**Item no.**

**UNIFLEX** B 8098 000 UN  
**QUADRA** B 8098 000 QU  
**RONDEA** B 8098 000 RO

**Metal labelling flag, Model BSFM**

For use with holding rod, randomly turn or fix.  
● Lacquered metal, W 400 mm, H 90 mm  
SchulzLabelingService upon request

**Item no.**

**UNIFLEX** B 8097 000 UN  
**QUADRA** B 8097 000 QU  
**RONDEA** B 8097 000 RO

## Labelling Boards

**Turn-board holder, Model WTH**  
For installation at front sides of shelves, for clear and open presentation of information, for max. 21 turn-boards in German DIN A4 format. Black plastic, without turn-boards.

**Item no.**

For installation on bearing frames of double-sided bays  
**UNIFLEX** B 8090 000 UN  
**QUADRA** B 8090 000 QU

For installation onto end panels or for wall-mounting  
**UNIFLEX** B 8091 000 UN  
**QUADRA** B 8091 000 QU

5 turn-boards for German DIN A4 format with double-sided labelling field, transparent plastic, incl. turning rod.  
**UNIFLEX** B 8092 000 UN  
**QUADRA** B 8092 000 QU



## Labelling Boards



**Labelling board with acrylic glass cover, Model BTP**

For hanging on front sides of single- or double-sided bays, for German DIN A4 format, with 6 mm acrylic glass cover, back is lacquered metal white, incl. fastening material. W 212 mm, H 301 mm  
Schulz Labeling Service upon request.

**Item no.**

1 each for single- or double-sided bays with shelf depth 250 mm (see picture 1)  
**UNIFLEX** B 8080 M40 UN  
**QUADRA** B 8080 M40 QU  
**RONDEA** B 8080 M40 RO

1 each for single- or double-sided bays with shelf depth 300 mm  
**UNIFLEX** B 8080 N40 UN  
**QUADRA** B 8080 N40 QU  
**RONDEA** B 8080 N40 RO

1 each for centre fixing in double-sided bays (see picture 2)  
**UNIFLEX** B 8080 044 UN  
**QUADRA** B 8080 044 QU  
**RONDEA** B 8080 044 RO

1 each for end panels from perforated plates, with round holes RG 5/25 (see picture 3)  
**UNIFLEX** B 8080 043 UN  
**QUADRA** B 8080 043 QU  
**RONDEA** B 8080 043

RO  
1 each for end panels from perforated plates, with square holes QG 10/62,5  
**UNIFLEX** B 8080 048 UN  
**QUADRA** B 8080 048 QU  
**RONDEA** B 8080 048 RO

1 each for wooden end panels (see picture 4)  
**UNIFLEX** B 8080 042 UN  
**QUADRA** B 8080 042 QU  
**RONDEA** B 8080 042 RO



## Shelf Labelling



### Tagboard, Model AKS 2

For clip onto metal or wooden shelves with below groove, shifting, incl. exchangeable labeling white strip transparent plastic, antireflex. W 210/105 mm, H 21 mm  
**Schulz** Labeling Service upon request

	Item no.
Tagboard B 210 mm	
<b>Fits all systems</b>	<b>B 8040 000 XX</b>
Blank labelling white strip, sheets of 13 strips, W 209 mm	
<b>Fits all systems</b>	<b>B 8041 000 XX</b>
Tagboard B 105 mm	
<b>Fits all systems</b>	<b>B 8040 200 XX</b>
Blank labelling white strip, sheets of 13 strips, W 104 mm	
<b>Fits all systems</b>	<b>B 8041 200 XX</b>

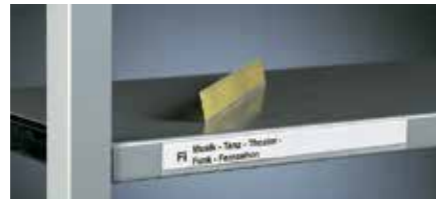

### Lettering tag, Model KA/S

For retrofitted installation on metal or wooden shelves with smooth edges, self-sticking, incl. exchangeable labelling white strip transparent plastic. W 147/200 mm, H 20 mm  
**Schulz** Labeling Service upon request

	Item no.
Labelling sign B 200 mm	
<b>Fits all systems</b>	<b>B 8044 200 XX</b>
Labelling sign B 147 mm	
<b>Fits all systems</b>	<b>B 8044 201 XX</b>
Blank labelling white strip, sheets of 13 strips, W 209 mm (shorter sizes by cutting)	
<b>Fits all systems</b>	<b>B 8041 000 XX</b>



### Magnet sign, Model KA/M

For metal boards with smooth edge, Magnetic, incl. exchangeable labelling white strip with transparent plastic cover. W 210 mm, H 20 mm  
**Schulz** Labeling Service upon request

	Item no.
<b>Fits all systems</b>	<b>B 8045 000 XX</b>
Blank labelling white strip, sheets of 13 strips, W 209 mm (shorter sizes by cutting)	
<b>Fits all systems</b>	<b>B 8041 000 XX</b>



### Labelling cube, Model BEWÜ

Universal use for all shelving systems, for attaching labelling between books, incl. inscription field with transparent cover and exchangeable labelling white cardboard, transparent plastic. W 120/200 mm, T 200, H 200 mm  
**Schulz** Labeling Service upon request

	Item no.
Labelling cube B 120 mm	
<b>Fits all systems</b>	<b>B 8060 000 XX</b>
Labelling cube B 200 mm	
<b>Fits all systems</b>	<b>B 8060 200 XX</b>



### Book substitute, Model STV

As substitute for when books are taken out etc., universal use for all shelving systems, with welded transparent pocket; white, blue, green or red plastic. W 153 mm, H 74 mm  
**Schulz** Labeling Service upon request

	Item no.
<b>Fits all systems</b>	<b>B 8061 000 XX</b>



### Labelling bearer, Model BET

Universal use by simply placing on shelf, incl. exchangeable labelling white strip; white lacquered metal. W 150 mm, D 150 mm, H 26 mm  
**Schulz** Labeling Service upon request

	Item no.
<b>Fits all systems</b>	<b>B 8019 000 XX</b>
Blank labelling white strip, sheets of 13 strips, W 209 mm (shorter sizes by cutting)	
<b>Fits all systems</b>	<b>B 8041 000 XX</b>

**Pictograms**  
 Self-sticking icons for orientation and guiding systems, W 130 mm x H 130 mm.  
 More icons and sizes upon request.

**Fits all systems**      **Item no.**  
 B 8554 . . . XX

<b>Item no.</b>	B 8554 001 XX	B 8554 002 XX							
<b>Item no.</b>	B 8554 003 XX	B 8554 004 XX	B 8554 041 XX	B 8554 042 XX	B 8554 029 XX	B 8554 030 XX			
<b>Item no.</b>	B 8554 005 XX	B 8554 006 XX	B 8554 017 XX	B 8554 018 XX	B 8554 031 XX	B 8554 032 XX			
<b>Item no.</b>	B 8554 007 XX	B 8554 008 XX	B 8554 019 XX	B 8554 020 XX	B 8554 033 XX	B 8554 044 XX			
<b>Item no.</b>	B 8554 009 XX	B 8554 010 XX	B 8554 021 XX	B 8554 022 XX	B 8554 043 XX	B 8554 034 XX			
<b>Item no.</b>	B 8554 011 XX	B 8554 012 XX	B 8554 023 XX	B 8554 024 XX	B 8554 035 XX	B 8554 036 XX			
<b>Item no.</b>	B 8554 013 XX	B 8554 014 XX	B 8554 025 XX	B 8554 026 XX	B 8554 037 XX	B 8554 038 XX			
<b>Item no.</b>	B 8554 015 XX	B 8554 016 XX	B 8554 027 XX	B 8554 028 XX	B 8554 039 XX	B 8554 040 XX			

## Colour Range

Colours carry a large expressiveness and are effective at first sight. Particularly in architecture does colouring play an important role. We are offering you the possibility of individually combining different surfaces with an extensive colour programme in order to design your furniture.

Library Furniture 2012/14

System Counter DIALOG

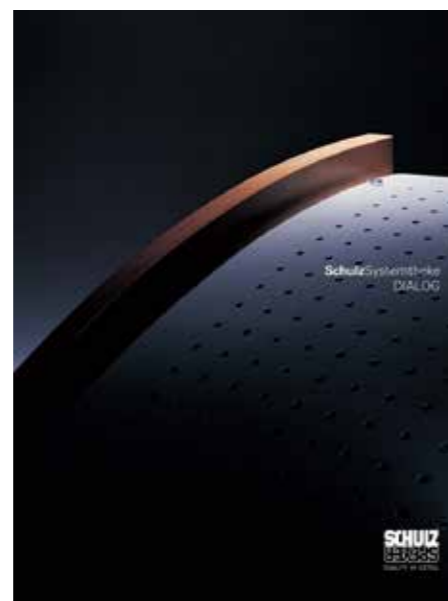

Price group

A

Price group

B

Price group

C

## We furnish libraries!

The centre of all our activities is you, our customer. Your satisfaction is our most important capital. In order to find your individual solution we already support you during the planning phase. If you are looking for competent consulting, We are there for you, also on the spot. Tell our specialists about your needs and use our know-how from many a thousand realised furnishing projects.



Our name stands for innovative product design and development. Furniture for today and tomorrow. And being an all-round equipper we offer a complete delivery programme for all kinds of libraries.

Besides the library furniture presented in this catalogue, you will find more product groups like shelving systems and shelving accessories as well as counter systems in separate catalogues or under [www.schulzspeyer.de](http://www.schulzspeyer.de).

We are looking forward to your inquiries.

Photo: M. J. Smets



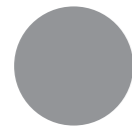

# Colours for metal coatings

The coloration of the metal parts is made by a highly abrasion-proof and environmental-friendly baking powder-coating. With reservation for colour deviations to original RAL register. Antibacterial equipping of surfaces upon request.

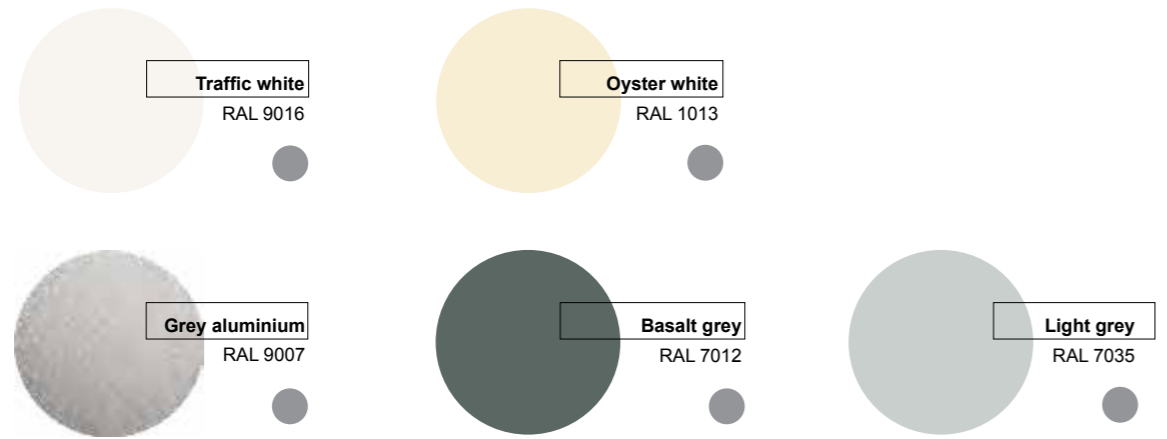

# Surfaces from solid wood veneer and plastic

Wooden surfaces are either directly plastic-coated or covered with an HPL laminated plastic, depending on their application. Differences in colour underline the characteristics of solid wood surfaces and cannot be avoided. Solid wood changes its colours under the influence of light. Table and work surfaces with solid wood veneer have only limited abrasion resistance. We recommend our highly resistant plastic decors for these types of surfaces. We use environmental-friendly lacquers for our solid wood surfaces.

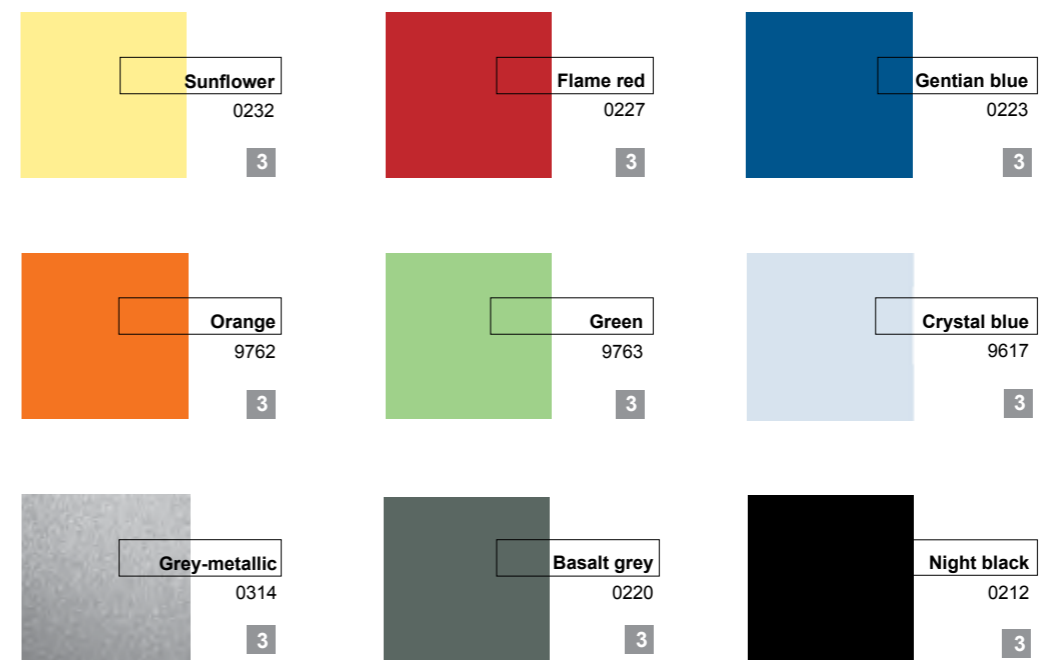
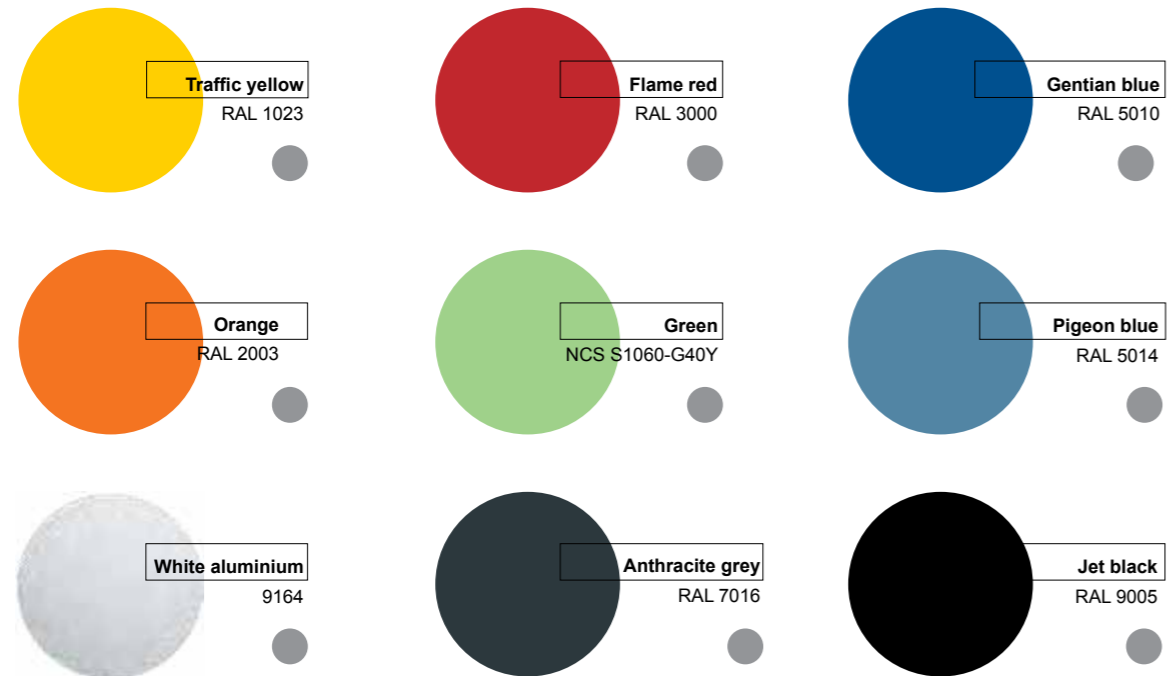
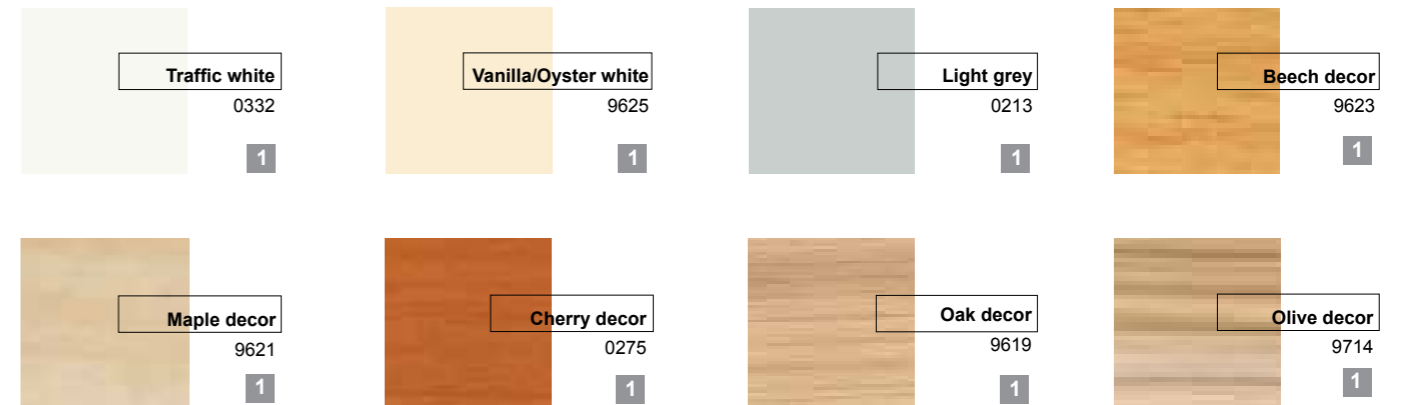

RAL 5003 Sapphire blue  
RAL 9011 Graphite black  
DB 702 Iron mica light  
DB 703 Iron mica dark  
Other colours, fine structures and glimmer lacquerings upon request.

(1) We do not recommend fine-structured surfaces for shelf boards as the books will slip easily!



Other surfaces and veneers upon request.